



# MANTION

[WWW.MANTION-MANUTENTION.COM](http://WWW.MANTION-MANUTENTION.COM)

*Chandelles d'accrochage sur charpente*

*Hangers for steel buildings*

*Zuganker für Stahlbau*



**822/2**





**Chandelle inclinable dans le sens de la charpente**  
Inclined hangers / Zugankern

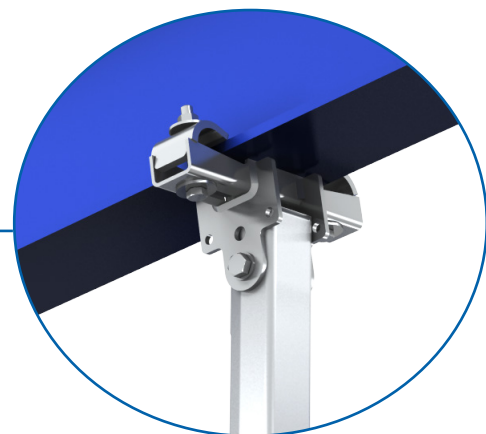

**Chandelle courte**

Short hanger / Kurze Aufhängungen

from IPE 180 - 360 to HEA 100 - 160

	ref	H (mm)	M
	9040 9047CC	155	M14
	9050 9057CC	160	M20
	9060 9067CC	165	M20

	ref	H (mm)	M
	10400 10567CC	158	M12
	10500 10567CC	158	M12
	10600 10667CC	170	M16

from IPE 300 - 600 to HEA 160 - 300

	ref	H (mm)	M
	9140 9147CC	160	M14
	9150 9157CC	165	M20
	9160 9167CC	170	M20

	ref	H (mm)	M
	11400 11567CC	163	M12
	11500 11567CC	163	M12
	11600 11667CC	175	M16

**Chandelle longueur spéciale**

Special length hanger / Lange Aufhängungen

from IPE 180 - 360 to HEA 100 - 160

	ref	H*	M
	9040 9047CLSP	xx	M14
	9050 9057CLSP	xx	M20
	9060 9067CLSP	xx	M20

	ref	H*	M
	10400 10567CLSP	xx	M12
	10500 10567CLSP	xx	M12
	10600 10667CLSP	xx	M16

from IPE 300 - 600 to HEA 160 - 300

	ref	H*	M
	9140 9147CLSP	xx	M14
	9150 9157CLSP	xx	M20
	9160 9167CLSP	xx	M20

	ref	H*	M
	11400 11567CLSP	xx	M12
	11500 11567CLSP	xx	M12
	11600 11667CLSP	xx	M16

## Chandelle à composer

To be composed hanger / Kombinationsmöglichkeiten eines Zugankers

### from IPE 180 - 360 to HEA 100 - 160

	ref	H (mm)	M
9040	10507CH	105	M14
9050		M14	
9060	10607CH	110	M14

	ref	H (mm)	M
10400	10507CH	105	M14
10500		M14	
10600	10607CH	110	M14

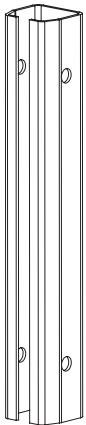
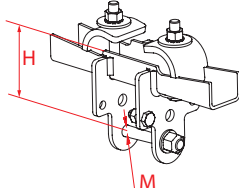

Profil 9050  
9050 profil  
9050 Schienenprofil

### from IPE 300 - 600 to HEA 160 - 300

	ref	H (mm)	M
9040	11507CH	110	M14
9050		M14	
9060	11607CH	115	M14

	ref	H (mm)	M
10400	11507CH	110	M14
10500		M14	
10600	11607CH	115	M14

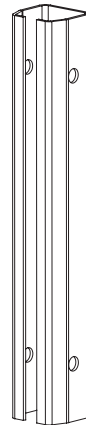
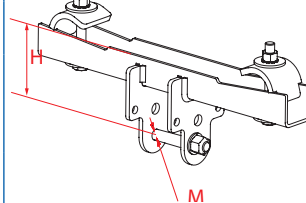

Profil 9050  
9050 profil  
9050 Schienenprofil

	ref	H (mm)	M
9040	9047CB	85	M14
9050	9057CB	90	M20
9060	9067CB	90	M20

	ref	H (mm)	M
10400	10507CB	88	M12
10500	10507CB	88	M12
10600	10607CB	95	M16

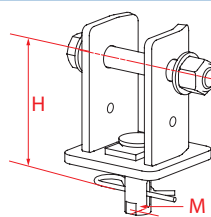
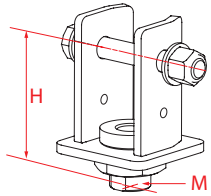

	ref	H (mm)	M
9040	9047CB	85	M14
9050	9057CB	90	M20
9060	9067CB	90	M20

  

	ref	H (mm)	M
10400	10507CB	88	M12
10500	10507CB	88	M12
10600	10607CB	95	M16

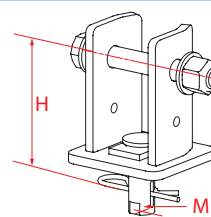
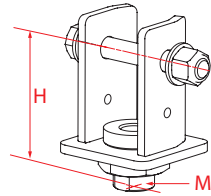

## Anti rotation + Triangulation + Gabarit de perçage

Anti rotating + stabilisation + Drilling template / Stabilisierung + Dreiecksaufnahme + Bohrschablone

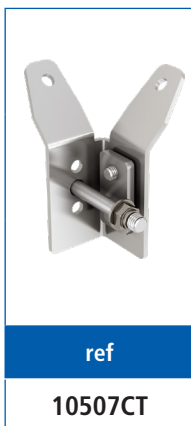



**Chandelle inclinable perpendiculaire à la charpente**  
Perpendicular inclined hangers / Quer Zuganker

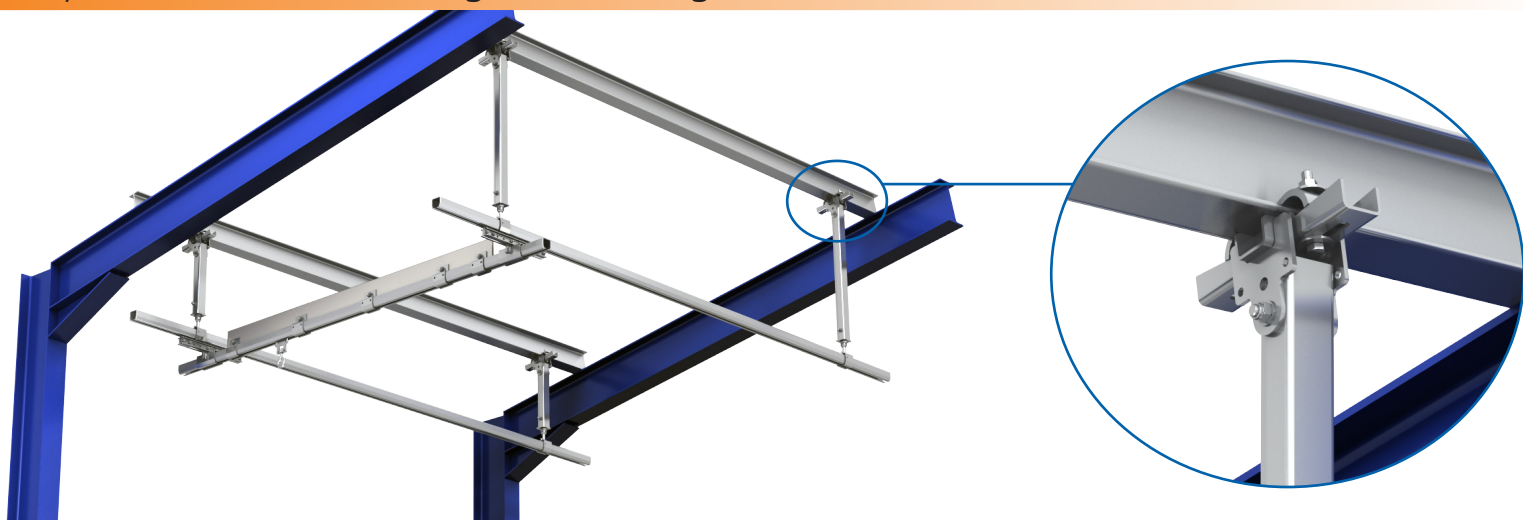

**Chandelle courte**

Short hanger / Kurze Aufhängungen

from IPE 100 - 360 to HEA 100 - 160

	ref	H (mm)	M	
	9040	9045CC	155	M14
	9050	9055CC	160	M20
	9060	9065CC	165	M20

	ref	H (mm)	M	
	10400	10565CC	158	M12
	10500	10565CC	158	M12
	10600	10665CC	170	M16

from IPE 300 - 600 to HEA 160 - 300

	ref	H (mm)	M	
	9040	9145CC	160	M14
	9050	9155CC	165	M20
	9060	9165CC	170	M20

	ref	H (mm)	M	
	10400	11565CC	163	M12
	10500	11565CC	163	M12
	10600	11665CC	175	M16

**Chandelle longueur spéciale**

Special length hanger / Lange Aufhängungen

from IPE 100 - 360 to HEA 100 - 160

	ref	H*	M	
	9040	9045CLSP	xx	M14
	9050	9055CLSP	xx	M20
	9060	9065CLSP	xx	M20

	ref	H*	M	
	10400	10565CLSP	xx	M12
	10500	10565CLSP	xx	M12
	10600	10665CLSP	xx	M16

from IPE 300 - 600 to HEA 160 - 300

	ref	H*	M	
	9040	9145CLSP	xx	M14
	9050	9155CLSP	xx	M20
	9060	9165CLSP	xx	M20

	ref	H*	M	
	10400	11565CLSP	xx	M12
	10500	11565CLSP	xx	M12
	10600	11665CLSP	xx	M16

## Chandelle à composer

To be composed hanger / Kombinationsmöglichkeiten eines Zugankers

### from IPE 100 - 360 to HEA 100 - 160

	ref	H (mm)	M
9040 9050	<b>10505CH</b>	105	M14
9060	<b>10605CH</b>	110	M14

	ref	H (mm)	M
10400 10500	<b>10505CH</b>	105	M14
10600	<b>10605CH</b>	110	M14

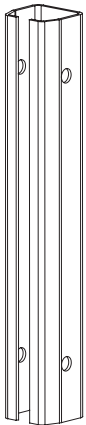

Profil 9050  
9050 profil  
9050 Schienenprofil

### from IPE 300 - 600 to HEA 160 - 300

	ref	H (mm)	M
9040 9050	<b>11505CH</b>	110	M14
9060	<b>11605CH</b>	115	M14

	ref	H (mm)	M
10400 10500	<b>11505CH</b>	110	M14
10600	<b>11605CH</b>	115	M14

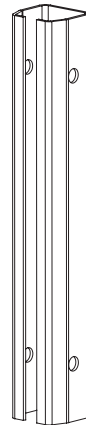

Profil 9050  
9050 profil  
9050 Schienenprofil

	ref	H (mm)	M
9040	<b>9047CB</b>	85	M14
9050	<b>9057CB</b>	90	M20
9060	<b>9067CB</b>	90	M20

	ref	H (mm)	M
10400	<b>10507CB</b>	88	M12
10500	<b>10507CB</b>	88	M12
10600	<b>10607CB</b>	95	M16

	ref	H (mm)	M
9040	<b>9047CB</b>	85	M14
9050	<b>9057CB</b>	90	M20
9060	<b>9067CB</b>	90	M20

	ref	H (mm)	M
10400	<b>10507CB</b>	88	M12
10500	<b>10507CB</b>	88	M12
10600	<b>10607CB</b>	95	M16

## Anti rotation + Triangulation + Gabarit de perçage

Anti rotating + stabilisation + Drilling template / Stabilisierung + Dreiecksaufnahme + Bohrschablone



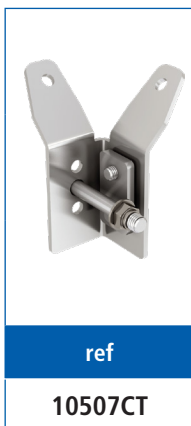

**Chandelle plafond béton**

Concrete roof hangers / Zuganker für Betondecke



**Chandelle longueur spéciale**

Special length hanger / Lange Aufhängungen

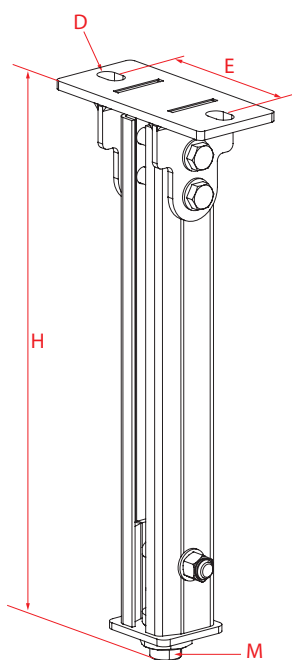

□	ref	H* (mm)	M	ØD (mm)	E (mm)	
	9040	9046CLSP	xx	M14	17	142
	9050	9056CLSP	xx	M20	17	142
	9060	9066CLSP	xx	M20	21	160

□	ref	H* (mm)	M	ØD (mm)	E (mm)	
	10400	10566CLSP	xx	M12	17	142
	10500	10566CLSP	xx	M12	17	142
	10600	10666CLSP	xx	M16	21	160

\* Cote à préciser à la commande  
specify dimension when ordering  
genaue Maße bei der Bestellung angeben

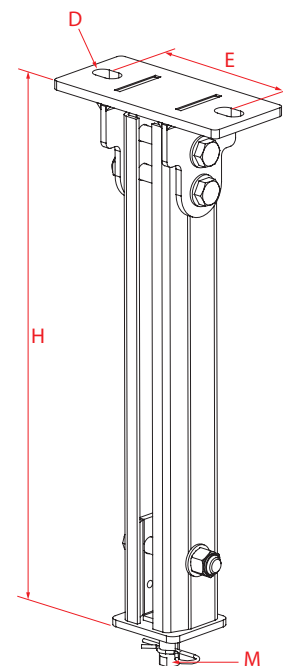

**Triangulation + Gabarit de perçage**

Stabilisation + Drilling template / Stabilisierung + Bohrschablone

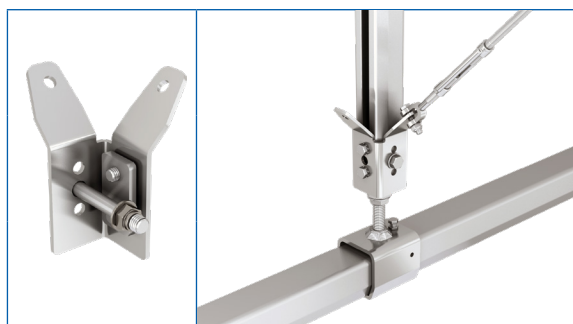

ref

10507CT









ref

10507GAB

## Chandelle à composer

To be composed hanger / Kombinationsmöglichkeiten eines Zugankers



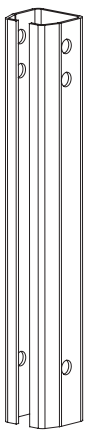

	ref	H (mm)	M (mm)	ØD (mm)	E (mm)	
	9040 9050	10506CH	78	M14	17	142
	9060	10606CH	80	M14	21	160
	ref	H (mm)	M (mm)	ØD (mm)	E (mm)	
	10400 10500	10506CH	78	M14	17	142
	10600	10606CH	80	M14	21	160

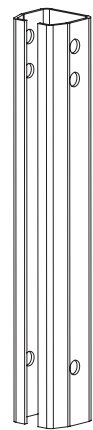





Profil 9050  
9050 profil  
9050 Schienenprofil



Profil 9050  
9050 profil  
9050 Schienenprofil

	ref	H (mm)	M	
	9040	9047CB	85	M14
	9050	9057CB	90	M20
	9060	9067CB	90	M20

	ref	H (mm)	M	
	10400	10507CB	88	M12
	10500	10507CB	88	M12
	10600	10607CB	95	M16

## Inox

Stainless steel / Edelstahl

Pour une version inox, veuillez nous consulter.

For a stainless steel version, please contact us.

Für eine Ausführung in Edelstahl, kontaktieren Sie uns bitte.

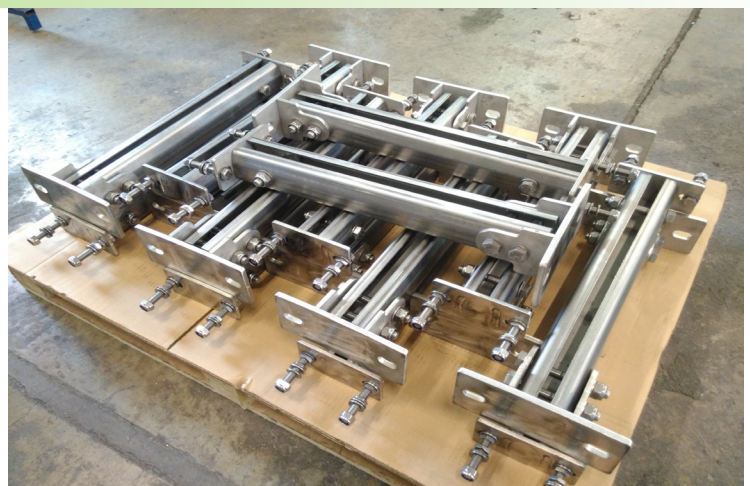



# MANTION

---

## MANUTENTION

### MANTION S.A.S

7 rue Gay Lussac  
F-25000 Besançon  
Tel. + 33 3 81 50 56 77  
Fax. + 33 3 81 53 29 76  
E-mail: [mantion@mantion.com](mailto:mantion@mantion.com)  
[www.mantion.com](http://www.mantion.com)

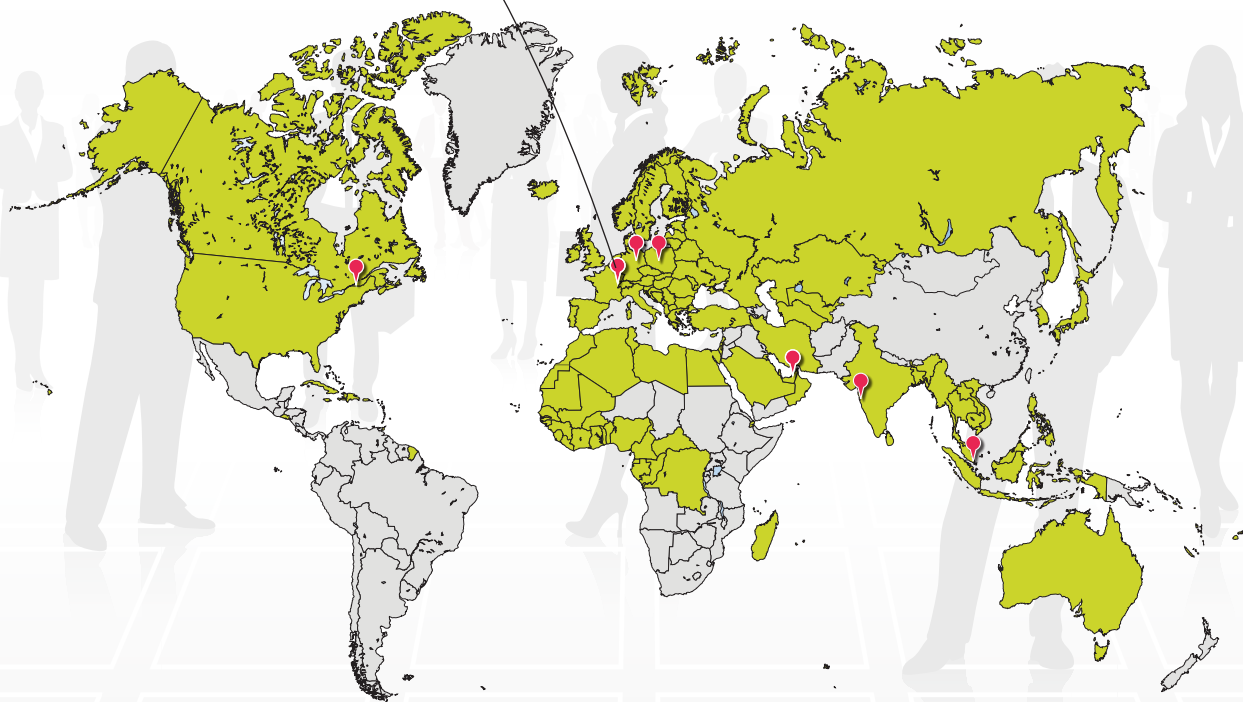

#### GERMANY / AUSTRIA MANTION BAUBESCHLÄGE GMBH

Dieselstraße 18  
D-42579 HEILIGENHAUS  
Tel. + 49 2056 58 26 90  
Fax. + 49 2056 58 26 99  
E-mail: [info@mantion.de](mailto:info@mantion.de)  
[www.mantion.de](http://www.mantion.de)

#### EAST EUROPE MANTION POLSKA

ul Boruty 2a  
PL-03 769 WARSZAWA  
Tel. + 48 22 818 77 22  
Fax. + 48 22 818 99 78  
E-mail: [biuro@valcomp.com.pl](mailto:biuro@valcomp.com.pl)  
[www.valcomp.com.pl](http://www.valcomp.com.pl)

#### MIDDLE EAST DUBAI BRANCH OFFICE

Jafza South, unit no. S101 23 O 032,  
Jebel Ali Free Zone, Dubai, UAE  
Tel. + 971 56 174 58 44  
E-mail: [export@mantion.com](mailto:export@mantion.com)  
[www.mantion.com](http://www.mantion.com)

#### INDIA MUMBAI BRANCH OFFICE

G-19, Ground floor,  
T.V. Estate, 248/A, S.K. Ahire Marg.  
Worli, Mumbai. 400 033. India.  
Mobile. + 91 9819 30 38 78  
E-mail: [a.gala@mantion.com](mailto:a.gala@mantion.com)  
[www.mantion.com](http://www.mantion.com)

#### SOUTH-EAST ASIA MANTION SOUTH EAST ASIA

Pte. Ltd. of 4 Battery Road,  
#25-01 Bank of China Building,  
Singapore 049908  
Mobile. + 65 9147 8440  
E-mail: [export@mantion.com](mailto:export@mantion.com)  
[www.mantion.com](http://www.mantion.com)

#### NORTH AMERICA MANTION NA

6-360 boul. Séminaire N  
Saint Jean sur Richelieu  
Tel. + 1 (450) 529 1315  
E-mail: [contact@mantion-na.com](mailto:contact@mantion-na.com)  
[www.mantion.ca](http://www.mantion.ca)