



PURTEC

BY MANTION

POUTRES ROULANTES ACIER & INOX

CRANES AND JIBS

KRANBAHN UND SCHWENKKRANSYSTEME

**FABRICATION
FRANÇAISE**



822



Un nouveau regard sur la MANUTENTION AÉRIENNE

🇬🇧 A new glance at the manual operated handling system

🇩🇪 Ein neuer Blick auf Handhängebahnsystem



🇫🇷 MANTION BÉNÉFICIE D'UNE NOTORIÉTÉ INTERNATIONALE QUI REPOSE SUR:

- L'innovation et l'adaptation permanente de ses produits aux besoins de ses clients.
- La qualité de ses produits respectant les normes les plus sévères du marché.

LE SAVOIR-FAIRE MANTION C'EST AVANT TOUT:

- Son équipe: des hommes et des femmes avec des compétences éprouvées, qui mettent tout en œuvre pour vous apporter, chaque jour, le meilleur service.
- Sa politique d'investissement permanent allié à l'utilisation des technologies les plus récentes.

AVEC MANTION, VOUS BÉNÉFICIEZ D'UN SERVICE DE TRÈS HAUTE QUALITÉ :

- Des technico-commerciaux à l'écoute de vos besoins.
- Une forte assistance technique: un bureau d'études et des conseillers techniques, chez vous à votre demande.
- L'étude et la réalisation de produits sur mesure.
- Des délais de livraison très rapides.
- Des produits de très haute qualité.

MANTION C'EST AUSSI UNE GAMME COMPLÈTE:

- Des ferrures de portes coulissantes et pliantes.
- Des ferrures de portes sectionnelles et battantes.
- Des ferrures de portes en verre.
- Des ferrures de portes en inox 304 L et 316 L.

MANTION, soucieux de vous apporter la meilleure prestation, tant au niveau de ses produits que de son organisation est certifié conforme aux exigences des normes:

ISO 9001
ISO 14001

🇬🇧 MANTION HAS AN INTERNATIONAL REPUTATION BASED ON:

- innovation and a permanent adaptation of its range of products to its customers' needs.
- a quality product, which responds to the requirements of the strictest standards.

THE MANTION KNOW-HOW MEANS BEFORE ALL:

- its team: people with experience and great skills who do their best to keep bringing you the best service.
- its permanent investment policy combined to the newest technologies.

WITH MANTION, YOU BENEFIT FROM A TOP QUALITY SERVICE:

- Salesmen who listen to your needs and advise you.
- A strong technical aid: an engineering department and technical advisers at your disposal.
- The study and the development of special products upon request.
- Very short delivery time.
- Very high quality products.

MANTION, THIS IS ALSO A COMPLETE RANGE:

- Fittings for sliding and folding doors.
- Fittings for sectional doors.
- Fittings for glass doors.
- Fittings in stainless steel quality A2 and A4.

Since MANTION has always cared about bringing you the best services within its organization and quality for its products, it is now up to standard:

ISO 9001
ISO 14001



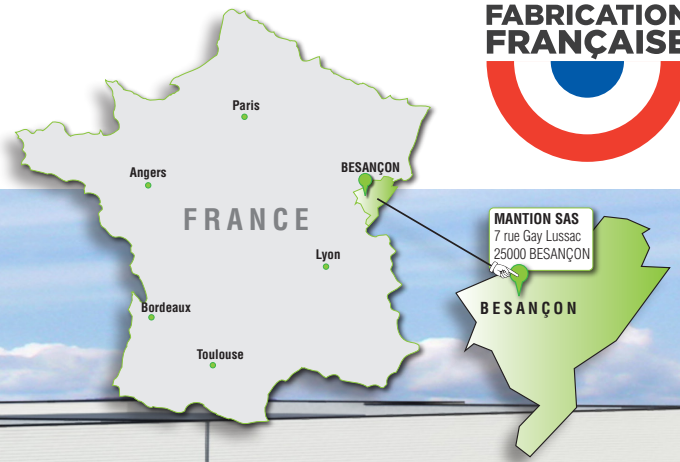

 **MANTION PROFITIERT VON EINEM INTERNATIONALEN BEKANNTHEITSGRAD, DER SICH STÜTZT AUF:**

- Die Innovation und die permanente Anpassung seiner Produkte an die Bedürfnisse seiner Kunden.
- Die Qualität seiner Produkte und Einhaltung der strengsten Normen des Marktes.

DAS KNOW-HOW VON MANTION IST VOR ALLEM:

- Das Team: Männer und Frauen mit erprobter Kompetenz, die ihr Bestes tun, um Ihnen jeden Tag aufs Neue den besten Service bieten zu können.
- Die Investitionspolitik, immer verbunden mit der Anwendung neuester Technologien.

MIT MANTION PROFITIEREN SIE VON EINEM SERVICE MIT HÖCHSTER QUALITÄT:

- Die technischen Angestellten sind immer für Sie da.
- Eine starke technische Unterstützung:

ein Forschungsbüro und technische Experten, die auf Wunsch zu Ihnen kommen.

- Das Studieren und Realisieren der Produkte auf Maß.
- Kurze Lieferzeiten.
- Produkte von sehr hoher Qualität.

MANTION: DAS IST AUCH EIN KOMPLETTES SORTIMENT:

- Beschläge für Schiebetore und Harmonikatüren.
- Beschläge für Sektional- und Flügeltore.
- Beschläge für Glastüren.
- Beschläge für Türen aus Edelstahl VA2 304 L und VA4 316 L.

MANTION ist darauf bedacht, die beste Leistung für Sie zu bringen, sowohl bei seinen Produkten als auch bei der Organisation. Manton ist zertifiziert nach den Anforderungen der Norm :

ISO 9001

ISO 14001

MANTION ET SON LABORATOIRE D'ESSAI:

Mantion soucieux de la qualité de ses produits, dispose de l'un des plus grands centres d'essais d'Europe dans le domaine du coulissant. En effet ce n'est pas moins de 5 bancs d'essai qui martyrisent à longueur d'année des systèmes coulissants, afin d'éprouver leur endurance. Tous les systèmes Mantion sont soumis à ces essais préalables, le tout réalisé avec la rigueur de la norme ISO 9001.

MANTION AND ITS TEST LABORATORY:

Mantion, which always focuses on the quality of its products, has one of the biggest test laboratories for sliding systems in Europe. 5 test stands enable Mantion to assay the endurance of all its sliding systems in order to comply with the requirements of the ISO 9001 standard.

MANTION UND SEIN PRÜFSZENTER:

Mantion, dem die Qualität seiner Produkte sehr am Herzen liegt, verfügt über eines der größten Prüfszenter Europas auf dem Gebiet von Schiebebeschlägen. Tatsächlich «quälen» nicht weniger als 5 Prüfstände das ganze Jahr Schiebeseysteme, um ihre Ausdauer zu prüfen. Alle Systeme von Mantion werden zuerst diesen Versuchen unterzogen, um den rauen Anforderungen der ISO 9001 gerecht zu werden.

Nos éléments standards permettent de réaliser aisément des installations personnalisées. La durée de vie des composants installés est variable selon ses conditions d'utilisation et de l'environnement dans lequel il se trouve. Dans tous les cas, elles doivent être déterminées par l'installateur. Celui-ci tiendra compte du fonctionnement, de l'espacement des supports, de la nature et du volume des charges transportées.

Nos articles sont garantis contre tout vice de fabrication, toutefois, cette garantie est limitée au remplacement des pièces défectueuses, à l'exclusion de tous dommages et intérêts, pour quelque cause que ce soit. Les pièces ayant subi une modification ou installées selon d'autres procédures (disponibles sur demande) que celles que nous recommandons ne bénéficierons pas de la garantie.

Our standard elements make possible to create easily personalized installations. The lifespan of the components installed is variable according to its environment and conditions of use. In all cases, they must be determined by the resaler. This one will take care of the running method, the spacing of the brackets, the nature and the volume of the transported loads.

Our products are warranted against manufacture fault, however, this warranty is limited to the replacement of the defective parts only and not for damages or consequential claims of any nature. Modified parts and material installed in a different way than the one we are recommended (recommandations available on demand) are not under warranty any more.

Unsere Standartelemente ermöglichen Konstruktionen, die Ihren persönlichen Wünschen entsprechen. Die Lebensdauer der Komponenten ist abhängig von Ihren Nutzungsbedingungen. Diese müssen von den Vertreter definiert werden. Er muss das Volumen, die Gewichte und die Aufhängungen berücksichtigen.

Unsere Produkte sind gewährleistet gegen Produktionsmängel. Die Gewährleistung ist jedoch begrenzt: Ersatz vom defekten Teilen, geänderte Teile und Material, Installationen nicht gemäß Mantion's Anweisung (zu Verfügung auf Anfrage) sind von der Gewährleistung ausgeschlossen.

Nos produits ne sont pas soumis à l'autocertification CE car ils sont vendus en tant que composants indépendants. Cela devient une machine lorsque ils sont montés sous une charpente par le constructeur. La certification CE doit alors être produite par le concepteur de l'installation.

Our product are not suitable for autocertification CE because they are sold as independants parts. They are becoming a machine when they are built up together linked with a steel construction. The CE certification have to be done by the installator.

Das Produkt entspricht erst der CE -Verordnung wenn es zusammengebaut ist. Die CE Zertifizierung erfolgt über den Hersteller, inklusive der Stahlbau Konstruktion.



Les diverses informations techniques présentes dans ce catalogue sont données à titre indicatif, vous ne pouvez les utiliser telles que. Il convient de vérifier ces informations sur nos fiches techniques ou nous consulter afin d'avoir la bonne définition du matériel en fonction de vos implantations et charges.

Nos fiches techniques sont disponibles sur notre site internet ou bien sur demande.

The technical information in this catalogue is for information purposes only and cannot be used as is.

Information should be cross-checked with technical data sheets or directly with us to ensure equipment corresponds to your installation site and loads.

Our technical data sheets are available via our website or on request.

„Bei den verschiedenen, in diesem Katalog aufgeführten technischen Angaben handelt es sich um Richtwerte, die nicht unmittelbar übernommen werden dürfen.

Diese Angaben sollten anhand unserer technischen Datenblätter überprüft bzw. bei uns erfragt werden, um eine geeignete Ausstattung passend zur jeweiligen Einbausituation und Belastung festzulegen.

Unsere technischen Datenblätter sind auf unserer Internetseite bzw. auf Anfrage erhältlich.“



POUTRES ACIER

STEEL CRANES / KLEINKRANANLAGE AUS STAHL

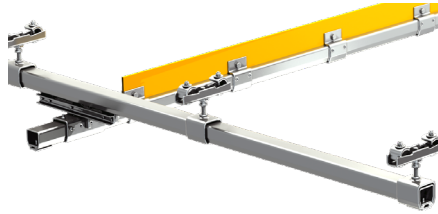

- Rails / Tracks / Schienen	08
- Renforts d'inertie / Inertia reinforcement / Kranbrückenverstärkung	10
- Sommiers rigides / Rigid end crane / Schiebebühnen-Fahrwerk starr.....	11
- Sommiers articulés / Articulated end crane / Schwenkbare Schiebebühnen-Fahrwerke.....	11
- Indexations / Inertia reinforcement / Verriegelung.....	16
- Sommiers spéciaux / Special end crane trolleys / Speziäle Kranbahnrollapparate.....	18
- Transbordeurs / Transfer station / Mehrfach Kranbahn.....	19
- Supports / Brakets / Muffe.....	22
- Jonction de rail / Brakets / Muffe.....	24
- Chandelles d'accrochage / Building hangers / Aufhängungen mit zugankern.....	26
- Tirants / Threaded rod / Zuganker	30
- Chariots / Trolleys / Transporthänger.....	32
- Anneaux ou Crochets / Rings or Hooks / Ring oder Haken.....	35
- Butées / Stoppers / Stopper	35

PORTE CÂBLE

CABLE CARRIERS / TRANSPORTWAGEN



- Porte câble / Cable carriers / Kabelwagen	36
- Porte tube / vacuum hose / Schlauchwagen	38
- Accessoires / Accessories / Zubehör	39

INOX

STAINLESS STEEL / EDELSTAHL



- Inox / Stainless steel / Edelstahl.....	40
---	----

Disclaimer: Images of products showcased in the catalogues are for representation purpose. The design and specifications are subject to change without any disturbance to the final application. The company reserves full right to discontinue the sales of the products or solutions mentioned in the catalogue and the company is not responsible for any damage or liability occurring owing to this.





Principe circuit poutre roulante acier

Steel cranes example / Kranbahnanlage in der Übersicht

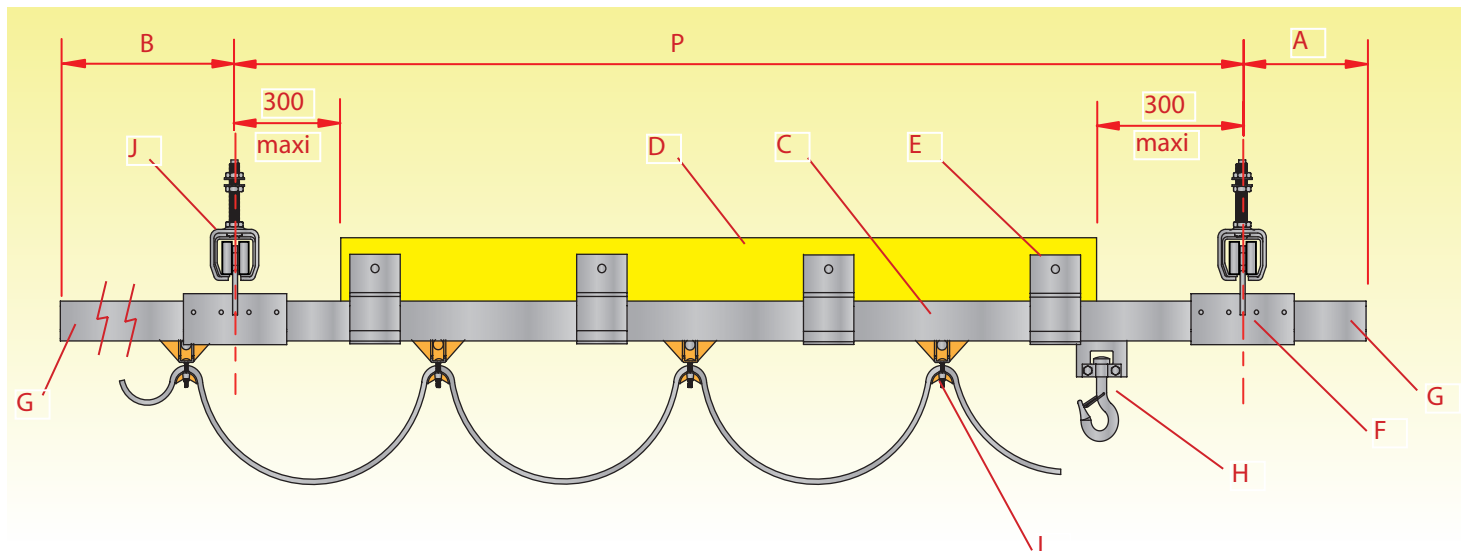

- A** = demi chariot + Lg butée
- B** = demi chariot + Lg butée + x fois la longueur des chariots porte câble
- C** = Rail poutre roulante
- D** = Renfort Inertie (si nécessaire)
- E** = Support à serrage
- F** = Sommier (rigide ou articulé)
- G** = Butée
- H** = Chariot + crochet ou anneau
- I** = Chariot porte câble
- J** = Voie de roulement
- P** = Portée

- A** = half trolley + stopper length
- B** = half trolley + stopper length + x times length of cable carriers
- C** = crane track
- D** = inertia reinforcement (if necessary)
- E** = clamping brackets
- F** = end crane trolleys (articulated or none)
- G** = stopper
- H** = trolley + hook or ring
- I** = cable carriers
- J** = straight lines
- P** = span

- A** = halber Laufwagen + Länge des Stoppers
- B** = halber Laufwagen + Länge des Stoppers + x-Mal die Länge der Kabelwagen
- C** = Kranbrückenschiene
- D** = Kranbrückenverstärkung (falls notwendig)
- E** = Klemmuffe
- F** = Schiebepöhlen-Fahrwerk (starr oder schwenkbar)
- G** = Stopper
- H** = Laufwagen + Haken oder Ring
- I** = Kabelwagen
- J** = Kranbahnschiene
- P** = Spannweite

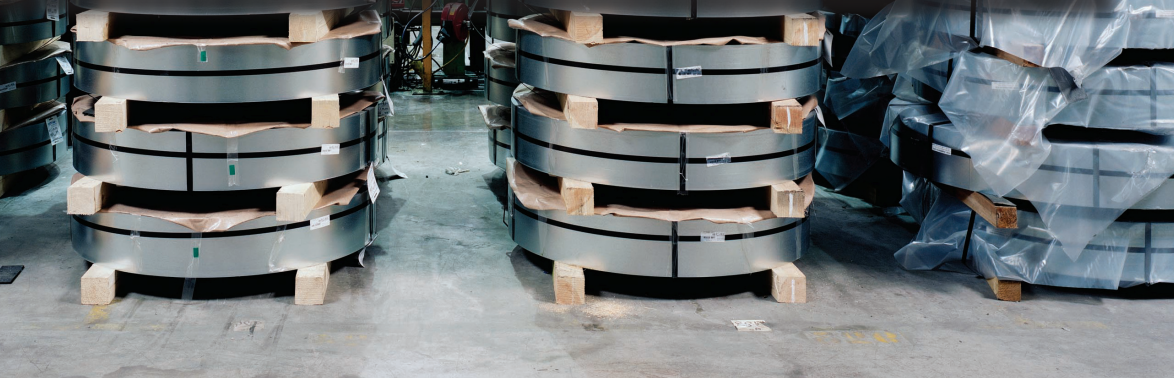
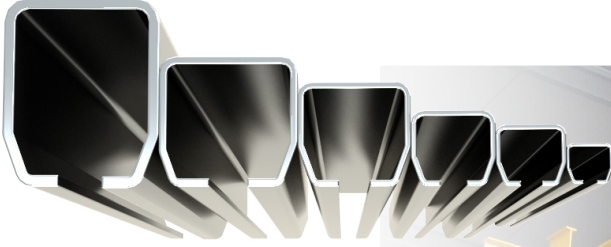

Choix du rail pour la poutre

Track's selection for the crane / Schienenauswahl für die Träger

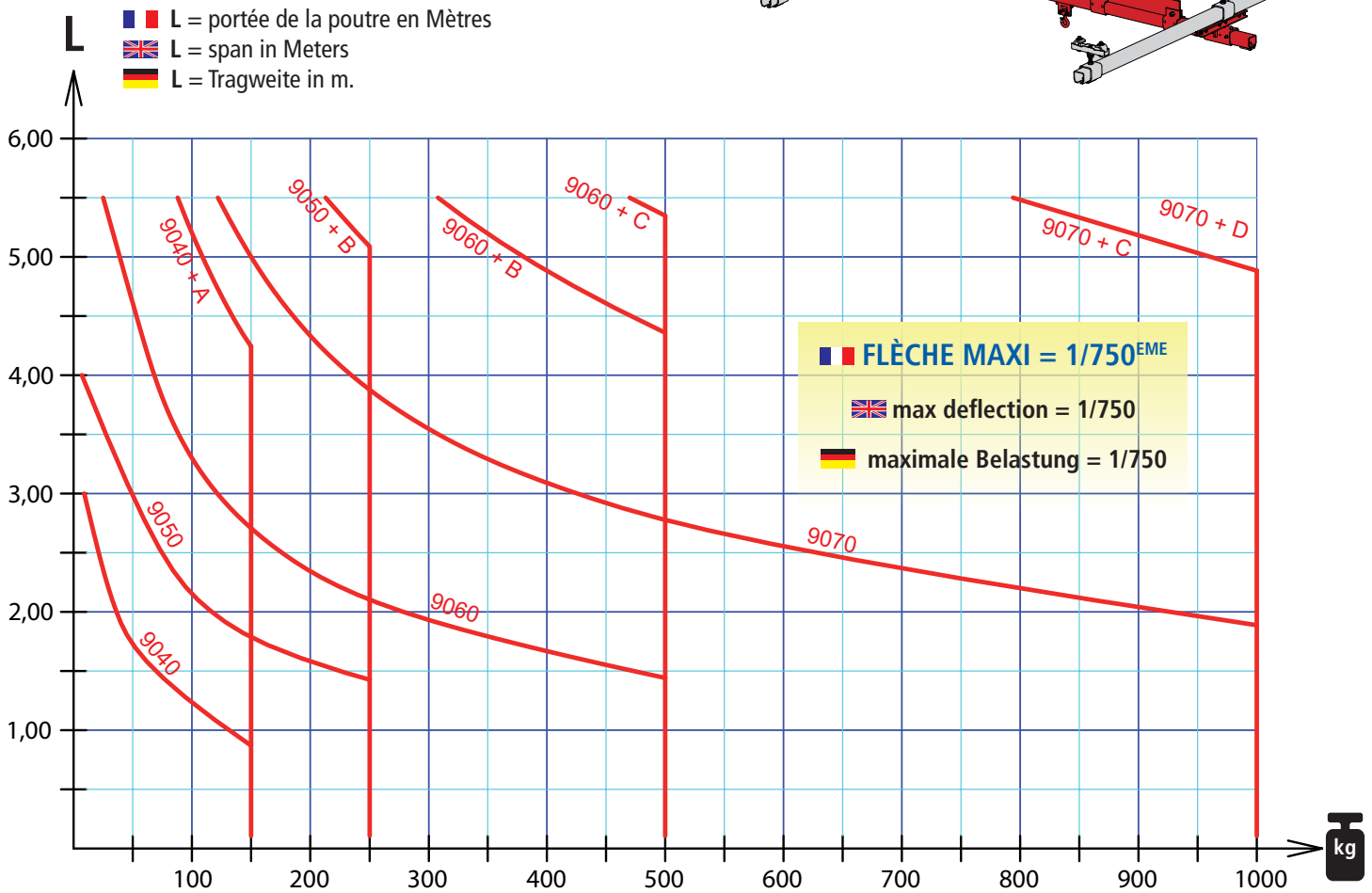
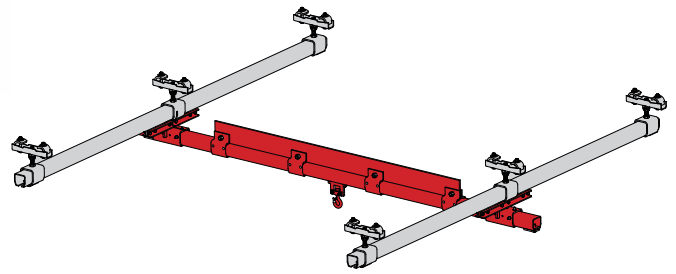

L	Charges en Kg. / Loads in Kg / Traglast in kg											
	100 Kg	150 Kg	200 Kg	250 Kg	300 Kg	350 Kg	400 Kg	450 Kg	500 Kg	700 Kg	800 Kg	1000 Kg
1,00 m	9040	9050 / 9040+A	9050	9050	9060	9060	9060	9060	9060	9070	9070	9070
1,50 m	9050 / 9040+A	9050 / 9040+A	9050	9050+B	9060	9060	9060	9060	9070 / 9060+B	9070	9070	9070
2,00 m	9050 / 9040+A	9060 / 9040+A	9060 / 9050+B	9060 / 9050+B	9070 / 9060+B	9070 / 9060+B	9070 / 9060+B	9070 / 9060+B	9070 / 9060+B	9070	9070	9070+C
2,50 m	9060 / 9040+A	9060 / 9040+A	9050+B	9050+B	9070 / 9060+B	9070 / 9060+B	9070 / 9060+B	9070 / 9060+B	9070 / 9060+B	9070+C	9070+C	9070+C
3,00 m	9060 / 9040+A	9040+A	9050+B	9050+B	9070 / 9060+B	9070 / 9060+B	9070 / 9060+B	9060+B	9060+B	9070+C	9070+C	9070+C
3,50 m	9040+A	9040+A	9050+B	9050+B	9070 / 9060+B	9060+B	9070 / 9060+B	9060+B	9060+B	9070+C	9070+C	9070+C
4,00 m	9040+A	9040+A	9070 / 9050+B	9050+B	9060+B	9060+B	9060+B	9060+B	9060+B	9070+C	9070+C	9070+C
4,50 m	9040+A	9050+B	9050+B	9050+B	9060+B	9060+B	9060+B	9060+B	9060+C	9070+C	9070+C	9070+C
5,00 m	9040+A	9050+B	9050+B	9050+B	9060+B	9060+B	9060+C	9060+C	9060+C	9070+C	9070+C	9070+D
5,50 m	9050+B	9050+B	9050+B	9050+B	9060+B	9060+C	9060+C	9060+C	9070+C	9070+C	9070+D	9070+D

■ ■ Renfort (voir p.10) / ■ ■ Reinforcement (see on p.10) / ■ ■ Verstärkung (siehe S.10) :

A = 100 x 8 mm

B = 120 x 10 mm

C = 150 x 10 mm

D = 180 x 10 mm

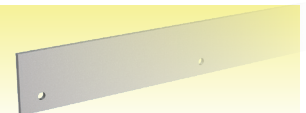

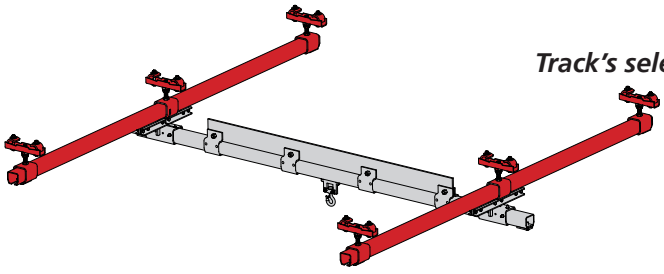

Choix du rail pour le chemin de roulement

Track's selection for the straight line / Schienenauswahl für die Laufbahnprofil





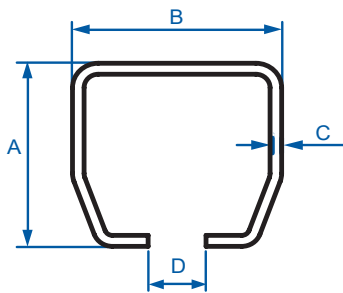
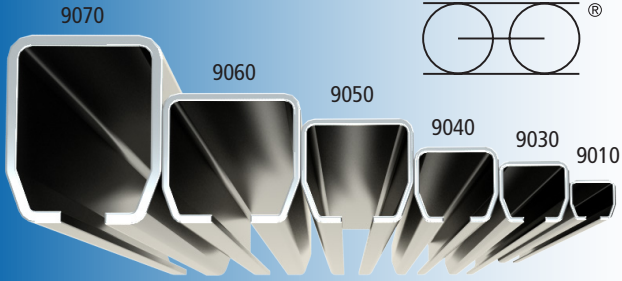

Les rails de notre fabrication portent le logo , c'est une garantie de qualité. IMPORTANT: les rails doivent être fixés de niveau grâce à nos supports spéciaux

The tracks manufactured by MANTION have their own logo , It is a guarantee of quality. IMPORTANT: Use our special brackets as the tubular profile must be level.

Schienen aus unserer Herstellung tragen das Logo . Dieses garantiert Qualität. WICHTIG: Die Schienen müssen mit unserem speziellen Befestigungsmaterial fixiert werden.



-  RAILS acier galvanisé
-  Galvanised steel track
-  Stahlschiene, galvanisch verzinkt

	Ref	A	B	C	D	Longueur Length Länge
9010	9010/600	28	30	1.8	10	6 m
9030	9030/600	35	40	2.5	12	6 m
9040	9040/600	43.5	48.5	3	15	6 m
9050	9050/600	60	65	3.5	18	6 m
9060	9060/600	75	80	4.5	22	6 m
	9060/900					9 m
9070	9070/600	110	90	6	25	6 m
	9070/900					9 m

CHARGE UNITAIRE ENTRE 2 POINTS / Load between 2 points / Punktuelle Belastung zwischen 2 Punkten

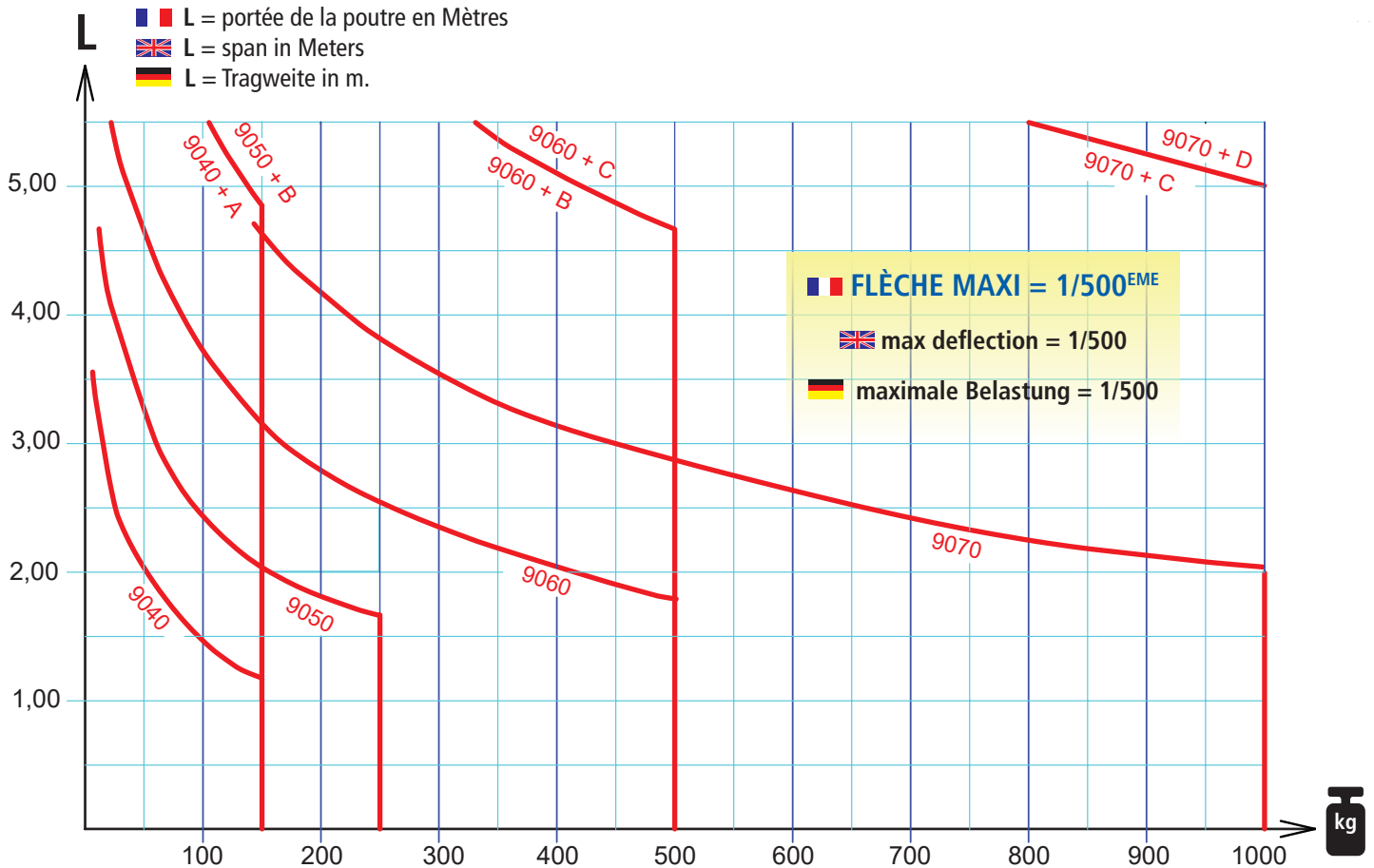

Renfort (voir p.10) / Reinforcement (see on p.10) / Verstärkung (siehe S.10):

A = 100 x 8 mm

B = 120 x 10 mm

C = 150 x 10 mm

D = 180 x 10 mm



RENFORTS D'INERTIE

Track reinforcement / Schienenverstärkung

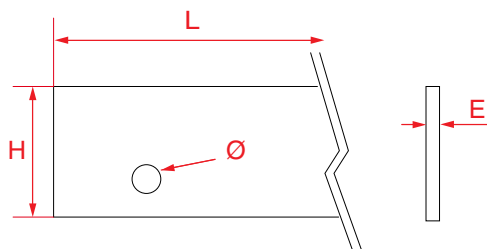
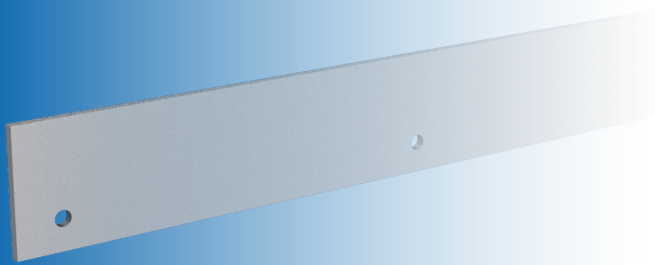

	ref	H	E	L	Ø
A	1700/083	100	8	3000	6 x Ø12.5
	1700/084			4000	8 x Ø12.5
	1700/085			5000	9 x Ø12.5
B	1720/103	120	10	3000	6 x Ø16.5
	1720/104			4000	8 x Ø16.5
	1720/105			5000	9 x Ø16.5
C	1750/105	150	10	5000	9 x Ø16.5
D	1780/105	180	10	5000	9 x Ø16.5

Renforts d'inertie

Les renforts sont livrés percés et peint avec une sous couche antirouille grise, ils doivent être montés sur nos rails au moyen des supports à serrage (9042N, 9052N, 9062N, 9072N)

Track reinforcement

The reinforcement are drilled and delivered grey painted against rust, they must be fixed on the tracks with clamping bracket 9042N, 9052N, 9062N or 9072N.

Schienenverstärkung:

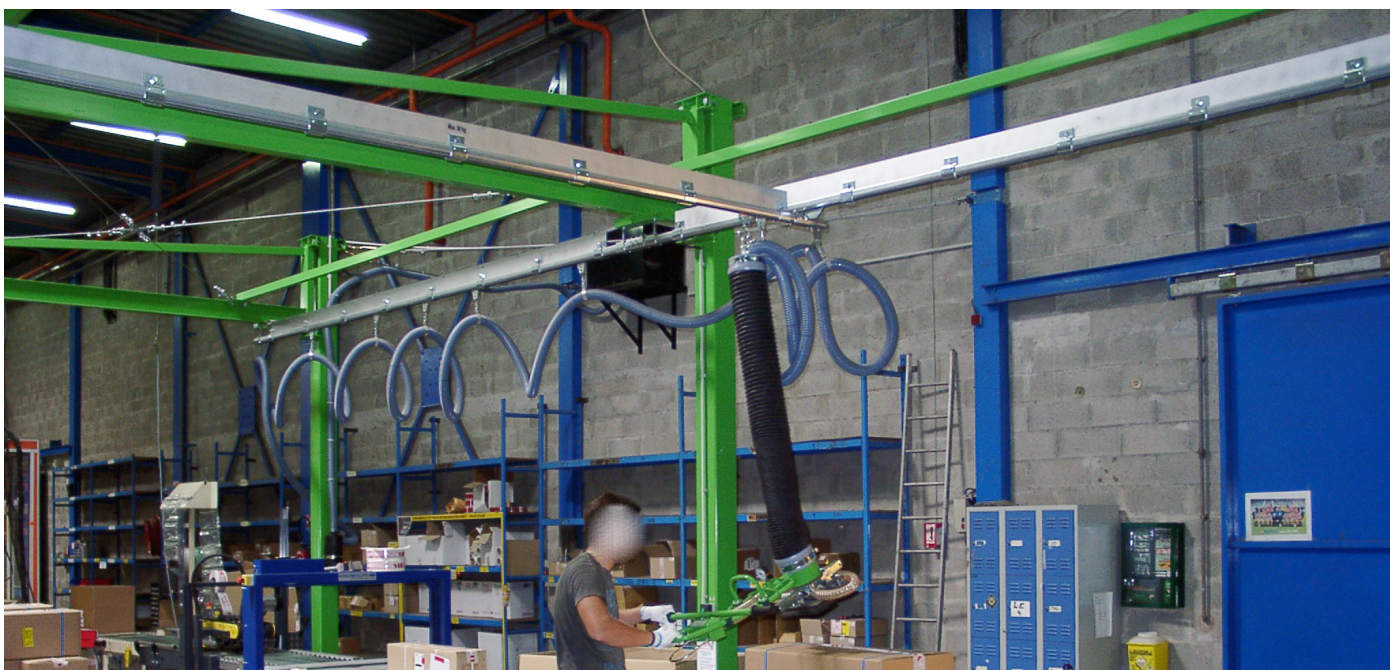
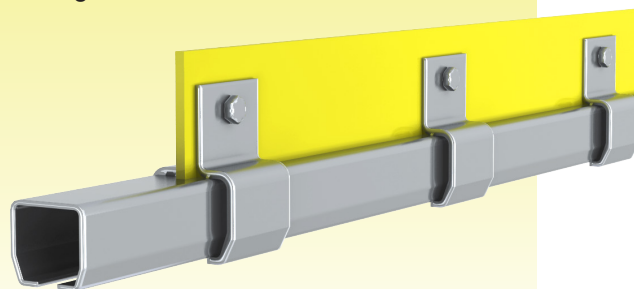

Die Verstärkungen sind gebohrt und müssen mit der Klemmmuffen 9042N, 9052N, 9062N, 9072N an der Schiene befestigt werden.

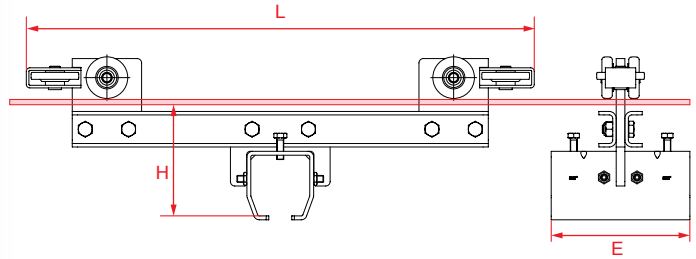

SOMMIERS RIGIDES

🇬🇧 Rigid end crane trolleys / 🇩🇪 Starre Schiebebühnen-Fahrwerke





□	ref	kg			L	H	E
9040	9748SR40	150	a	bp	586	107	135
9050	9758SR50	250	a	bp	586	132	160
9060	9768SR60	500	a	bp	611	149	205
9070	9778SR70	1000	a	bp	669	190.5	220

SOMMIERS ARTICULÉS

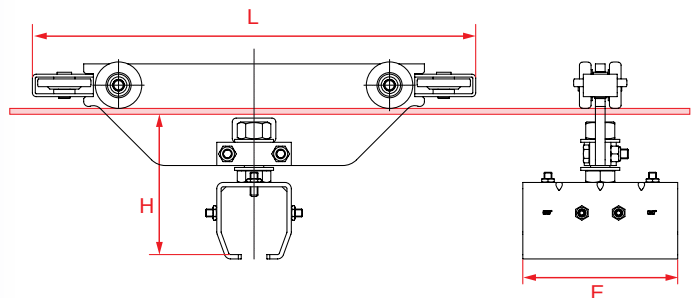
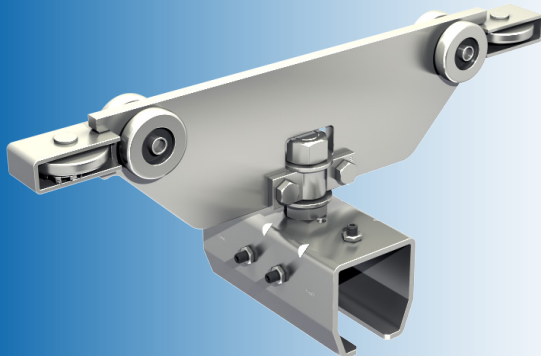
🇬🇧 Articulated end crane trolleys / 🇩🇪 Schwenkbare Schiebebühne-Fahrwerke



□	ref	kg			L	H	E
9040	9848SA40	150	a	bp	416	117	135
9050	9858SA50	250	a	bp	458	147.5	160
9060	9868SA60	500	a	bp	501	177	205
9070	9878SA70	1000	a	bp	614	232	220

🇫🇷 **Galets** : a = acier
Paliers : bp = billes de précision

🇬🇧 **Roller** : a = steel
Axle : bp = precision ball

🇩🇪 **Rollen** : a = Stahl
Lager : bp = Präzisionskugellager

🇫🇷 Les sommiers articulés sont conseillés lorsque le parfait parallélisme entre les voies de roulement n'est pas garanti ou lorsque la portée est grande. Ils diminuent le risque de coincement. Il ne faut jamais faire de jonction de rail sur la poutre mobile. La charge maximum admissible doit être indiquée sur l'installation. Demandez notre notice technique pour plus de précisions.

🇬🇧 If you can't ensure a perfect parallelism between the tracks or if the span is big, it's recommended to use the articulated end crane trolleys, they are helping for a better displacement of the beam. Never use a track junction on the span. The maximum load has to be put on the installation. Ask for our technical documentation for more details.

🇩🇪 Wenn die Herstellung einer perfekten Parallelität zwischen den Laufbahnen nicht sichergestellt werden kann, sowie bei großem Abstand zwischen den Laufbahnen, ist der Einsatz von Laufwagen mit Gelenk zu empfehlen. Bitte nie Schiene auf den bewegliche Trägern verbinden. Auf der Schiene muss die maximale Traglast der Schiebebühnen angegeben werden. Für mehr Details fragen Sie nach unseren technische Unterlagen.



Poutres acier

Steel cranes / Kleinkrananlage aus Stahl

- SOMMIERS RIGIDES À COMPOSER**
- ARTICULATED END CRANE TO COMPOSE**
- ROLLWAGEN ZUSAMMEN BAUEN**

SOMMIERS RIGIDES - MODULATIONS POSSIBLES :

Rigid end crane trolleys - possibilities :

Starre Schiebebühnen-Fahrwerke - verschiedene Kombinationsmöglichkeiten :

Poutre Cranes Kranbrückenprofil	Voies de roulements / Straight lines / Laufbahnprofil			
	9040	9050	9060	9070
9040	(2x) 9747CG (1x) 9747TS (1x) 9747MP Max = 150 Kg	(2x) 9757CG (1x) 9747TS (1x) 9747MP (2x) 9700ENT02 Max = 150 Kg	(2x) 9767CG (1x) 9747TS (1x) 9747MP (4x) 9700ENT02 Max = 150 Kg	
9050	(2x) 9747CG (1x) 9747TS (1x) 9757MP (4x) 9700ENT01 Max = 150 Kg	(2x) 9757CG (1x) 9757TS (1x) 9757MP Max = 250 Kg	(2x) 9767CG (1x) 9757TS (1x) 9757MP (2x) 9700ENT02 Max = 250 Kg	(2x) 9777CG (1x) 9757TS (1x) 9757MP (2x) 9700ENT02 Max = 250 Kg
9060	(2x) 9747CG (1x) 9747TS (1x) 9767MP (8x) 9700ENT01 Max = 150 Kg	(2x) 9757CG (1x) 9757TS (1x) 9767MP (4x) 9700ENT01 Max = 250 Kg	(2x) 9767CG (1x) 9767TS (1x) 9767MP Max = 500 Kg	(2x) 9777CG (1x) 9767TS (1x) 9767MP Max = 500 Kg
9070		(2x) 9757CG (1x) 9757TS (1x) 9777MP (4x) 9700ENT01 Max = 250 Kg	(2x) 9767CG (1x) 9767TS (1x) 9777MP Max = 500 Kg	(2x) 9777CG (1x) 9777TS (1x) 9777MP Max = 1000 Kg

EXEMPLE / EXAMPLE / BEISPIEL:

- Poutre
- Cranes
- Kranbrückenprofil

→ **9040**

+

- Voies de roulements
- Straight lines
- Laufbahnprofil

→ **9060**

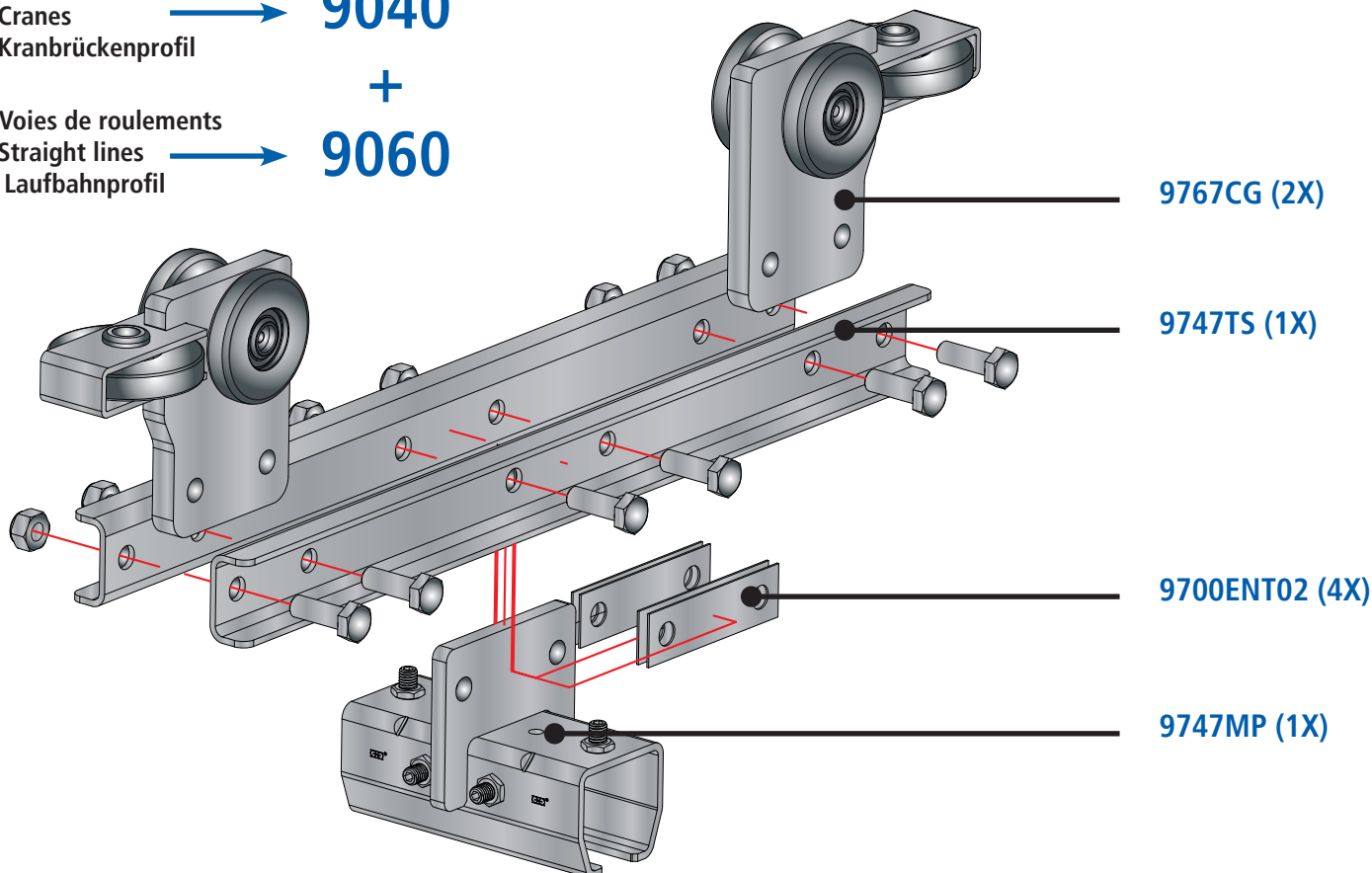



CHARIOT GUIDE

Guiding trolley / Führungsrollapparate

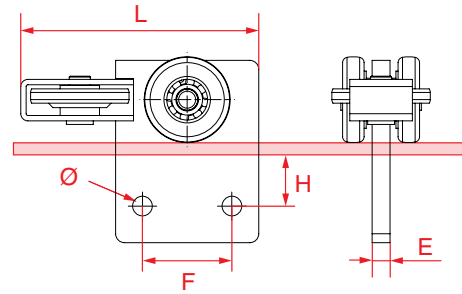
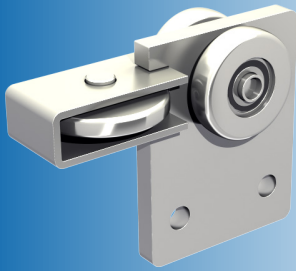

□	ref	kg	L	E	F	Ø	H
9040	9747CG	75	133	8	50	11	30
9050	9757CG	125	133	10	50	11	32
9060	9767CG	250	147	12	50	11	34
9070	9777CG	500	174.5	12	50	11	37.5

TRAVERSE DE SOMMIER

End crane bar / Traversen für Schiebebühnenfahrwerke

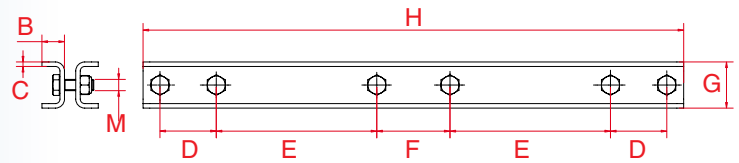
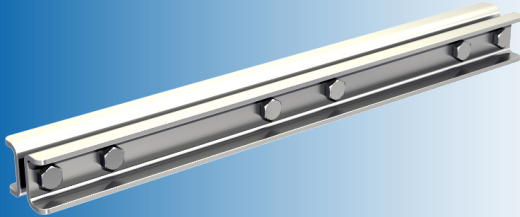

□	ref	kg	B	C	D	E	F	G	H	M
9040	9747TS	150	20	3	50	142.5	65	41	480	M10
9050	9757TS	250	20	4	50	142.5	65	41	480	M10
9060	9767TS	500	26	5	50	142.5	65	41	480	M10
9070	9777TS	1000	30	6	50	142.5	65	43	480	M10

MANCHON DE POUTRE

Crane sleeve / Muffen für Kranbrücke

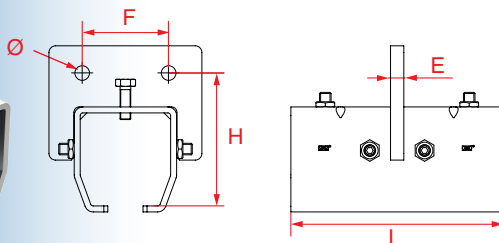
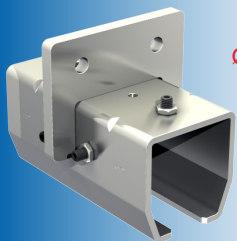

□	ref	kg	L	E	F	Ø	H
9040	9747MP	150	135	8	65	11	77
9050	9757MP	250	160	10	65	11	100
9060	9767MP	500	205	12	65	11	115
9070	9777MP	1000	220	12	65	11	153

ENTRETOISES

Spacers / Zwischenstück

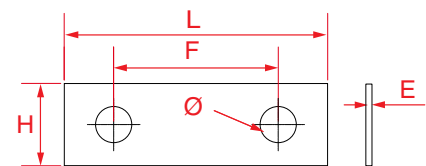
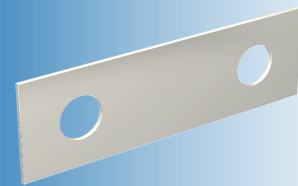

ref	L	E	F	Ø	H
9700ENT01	80	1	50	11	25
9700ENT02	90	1	65	11	25

■ ■ **SOMMIERS ARTICULÉS - MODULATIONS POSSIBLES :**

■ ■ Articulated end crane trolleys - possibilities :
 ■ ■ Schwenkbare Laufwerke - verschiedene Kombinationsmöglichkeiten

■ ■ Poutre ■ ■ Cranes ■ ■ Kranbrückenprofil	■ ■ Voies de roulements / ■ ■ Straight lines / ■ ■ Laufbahnprofil			
	9040	9050	9060	9070
9040	(1x) 9847CGA (1x) 9847MPA Max = 150 Kg	(1x) 9857CGA (1x) 9847MPA Max = 150 Kg	(1x) 9867CGA (1x) 9847MPA Max = 150 Kg	
9050	(1x) 9847CGA (1x) 9857MPA Max = 150 Kg	(1x) 9857CGA (1x) 9857MPA Max = 250 Kg	(1x) 9867CGA (1x) 9857MPA Max = 250 Kg	(1x) 9877CGA20 (1x) 9857MPA Max = 250 Kg
9060	(1x) 9847CGA (1x) 9867MPA Max = 150 Kg	(1x) 9857CGA (1x) 9867MPA Max = 250 Kg	(1x) 9867CGA (1x) 9867MPA Max = 500 Kg	(1x) 9877CGA20 (1x) 9867MPA Max = 500 Kg
9070		(1x) 9857CGA (1x) 9877MPA20 Max = 250 Kg	(1x) 9867CGA (1x) 9877MPA20 Max = 500 Kg	(1x) 9877CGA30 (1x) 9877MPA30 Max = 1000 Kg

EXEMPLE / EXAMPLE / BEISPIEL:

■ ■ Poutre
 ■ ■ Cranes
 ■ ■ Kranbrückenprofil

→ **9040**

+

■ ■ Voies de roulements
 ■ ■ Straight lines
 ■ ■ Laufbahnprofil

→ **9060**

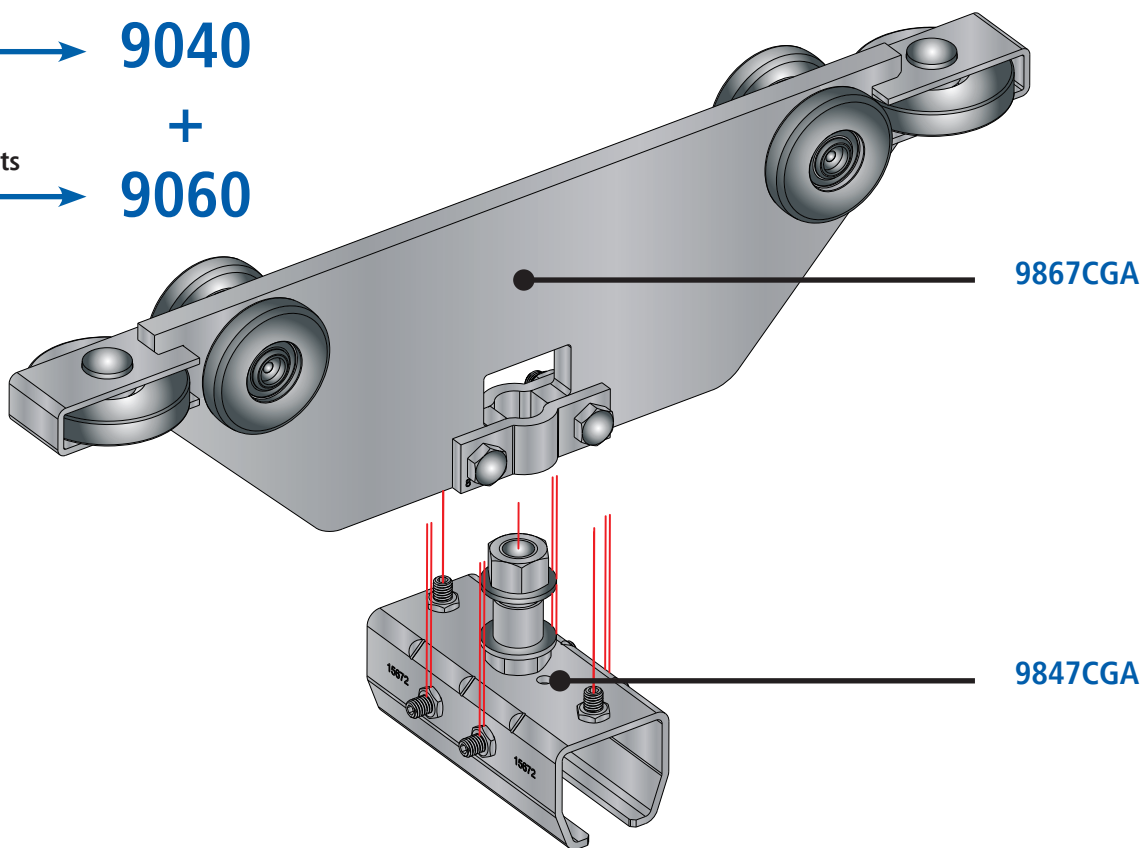

■ ■ Les sommiers articulés sont conseillés lorsque le parfait parallélisme entre les voies de roulement n'est pas garanti ou lorsque la portée est grande. Ils diminuent le risque de coincement. Il ne faut jamais faire de jonction de rail sur la poutre mobile. La charge maximum admissible doit être indiquée sur l'installation. Demandez notre notice technique pour plus de précisions.



■ ■ If you can't ensure a perfect parallelism between the tracks or if the span is big, it's recommended to use the articulated end crane trolleys, they are helping for a better displacement of the beam. Never use a track junction on the span. The maximum load has to be put on the installation. Ask for our technical documentation for more details.

■ ■ Wenn die Herstellung einer perfekten Parallelität zwischen den Laufbahnen nicht sichergestellt werden kann, sowie bei großem Abstand zwischen den Laufbahnen, ist der Einsatz von Laufwagen mit Gelenk zu empfehlen. Bitte nie Schiene auf den bewegliche Trägern verbinden. Auf der Schiene muss die maximale Traglast der Schiebebühnen angegeben werden. Für mehr Details fragen Sie nach unseren technische Unterlagen.

■ ■ CHARIOT GUIDE ARTICULÉ

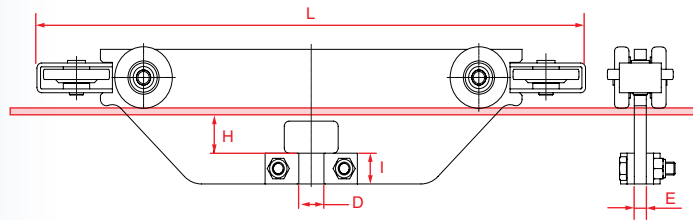
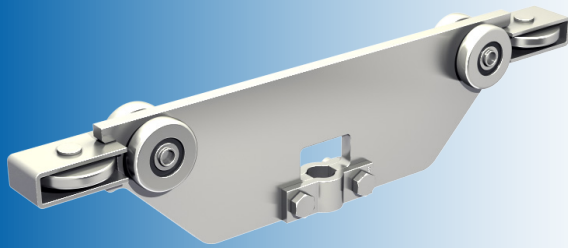
🇬🇧 Articulated guiding trolley / 🇩🇪 Schwenkbare Führungsrollapparate



□	ref	kg			L	H	I	D	E
9040	9847CGA	150	a	bp	416	30	24	21	8
9050	9857CGA	250	a	bp	458	31.5	24	21	10
9060	9867CGA	500	a	bp	501	46.5	24	21	12
9070	9877CGA20	1000	a	bp	614	40	24	21	12
9070	9877CGA30	1000	a	bp	614	49	30	31	12

■ ■ Galets : a = acier
Paliers : bp = billes de précision

🇬🇧 Roller : a = steel
Axle : bp = precision ball

🇩🇪 Rollen : a = Stahl
Lager : bp = Präzisionskugellager

■ ■ MANCHON DE POUTRE ARTICULÉ

🇬🇧 Articulated crane sleeve / 🇩🇪 Muffe für Rollapparate

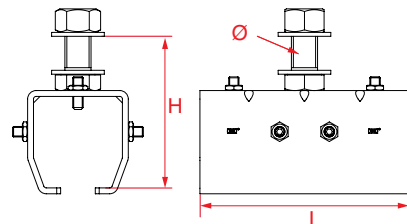
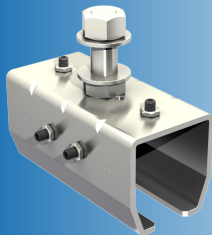

□	ref	kg	H	L	Ø
9040	9847MPA	150	86.5	135	20
9050	9857MPA	250	116	160	20
9060	9867MPA	500	130.5	205	20
9070	9877MPA20	500	165.5	220	20
9070	9877MPA30	1000	183	220	30



INDEXATION MOBILE MANUELLE

 Manual movable locks /  Bewegliche Verriegelung - Manuell

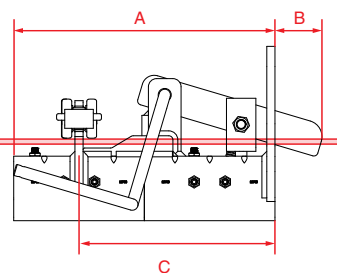
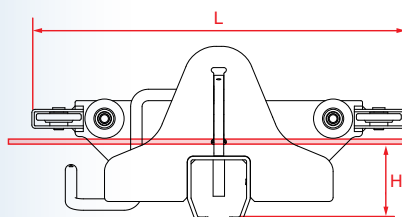
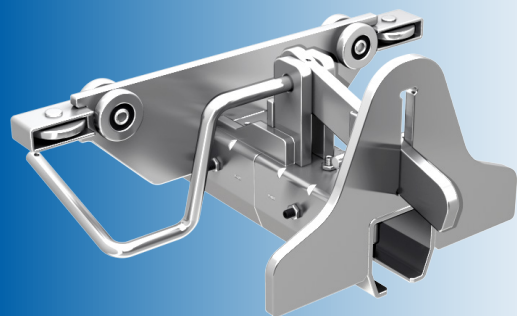



□	ref	kg	L	H	A	B	C
9040	9401VM	150	416	63	270	50	202.5
9050	9501VM	250	458	93	320	58	240
9060	9601VM	500	501	120	410	58	307.5
9070	9701VM	1000	614	158	440	48	330

KIT CHAÎNE DE MANOEUVRE /  Chain kit for manual operating /  Manuelle Betätigung

Ref. 9000CDE1





 Kit chaîne de manoeuvre simple pour commande manuelle. Ce kit comprend 1 chaînette de longueur 4 m. avec boule.
 Single chain kit for manual operating. This kit includes a chain of 4 m. with ball
 1 Kette (4M Lang) mit Kugel

INDEXATION MOBILE PNEUMATIQUE

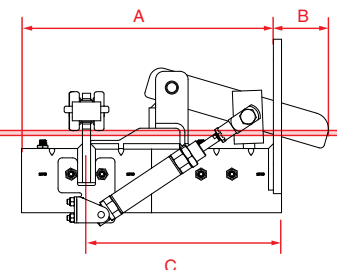
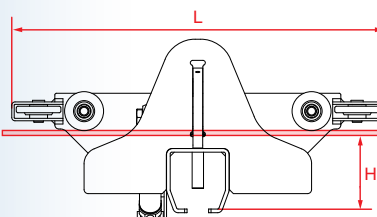
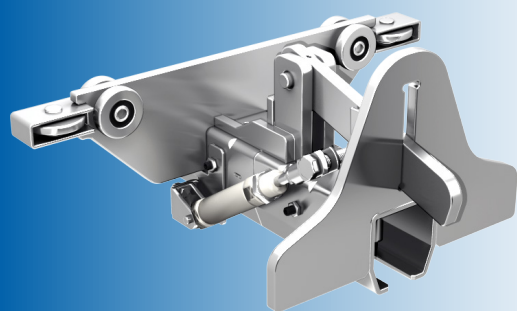
 Pneumatic movable locks /  Bewegliche Verriegelung - Pneumatisch



 Raccords sur vérins simple effet = 1/8F - Distributeur pneumatique non fourni.
 Connections on simple-acting jack = 1/8F - Pneumatic valve not provided
 Verbindungsstück auf einfachwirkender Zylinder = 1/8F pneumatisches Ventil nicht

□	ref	kg	L	H	A	B	C
9040	9401VMP	150	416	63	270	50	202.5
9050	9501VMP	250	458	93	320	58	240
9060	9601VMP	500	501	120	410	58	307.5
9070	9701VMP	1000	614	158	440	48	330

INDEXATION FIXE

Fixed locks / Starre Verriegelung

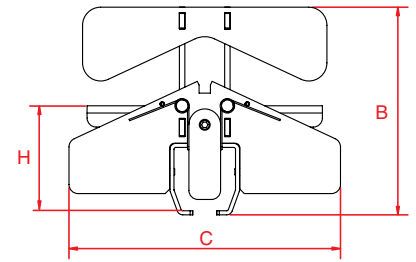
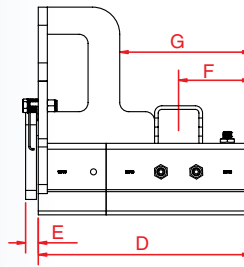
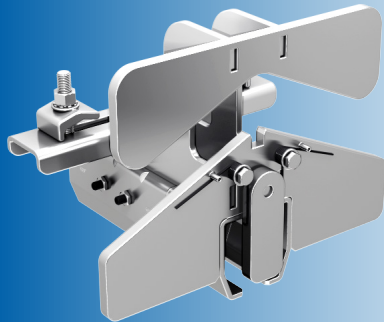

□	ref	B	C	D	E	F	G	H
9040	9401VF	187	270	200	14	67.5	135	77
9050	9501VF	229	300	235	14	80	145	116
9060	9601VF	260	340	315	17	103	225	135
9070	9701VF	285	360	330	17	110	250	200

SOMMIER RIGIDE POUR INDEXATION MOBILE MANUELLE OU PNEUMATIQUE

Rigid end crane trolleys for locks / Kranbahnrollapparat starr

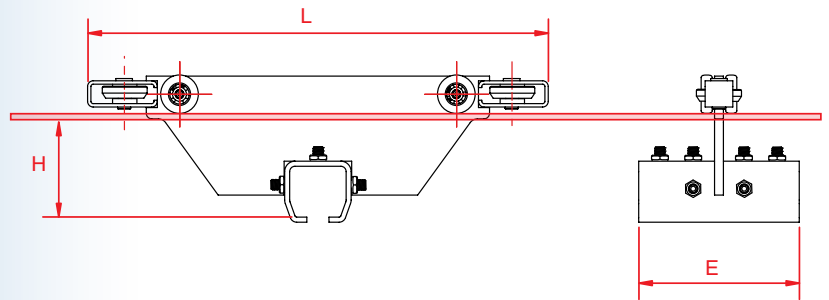

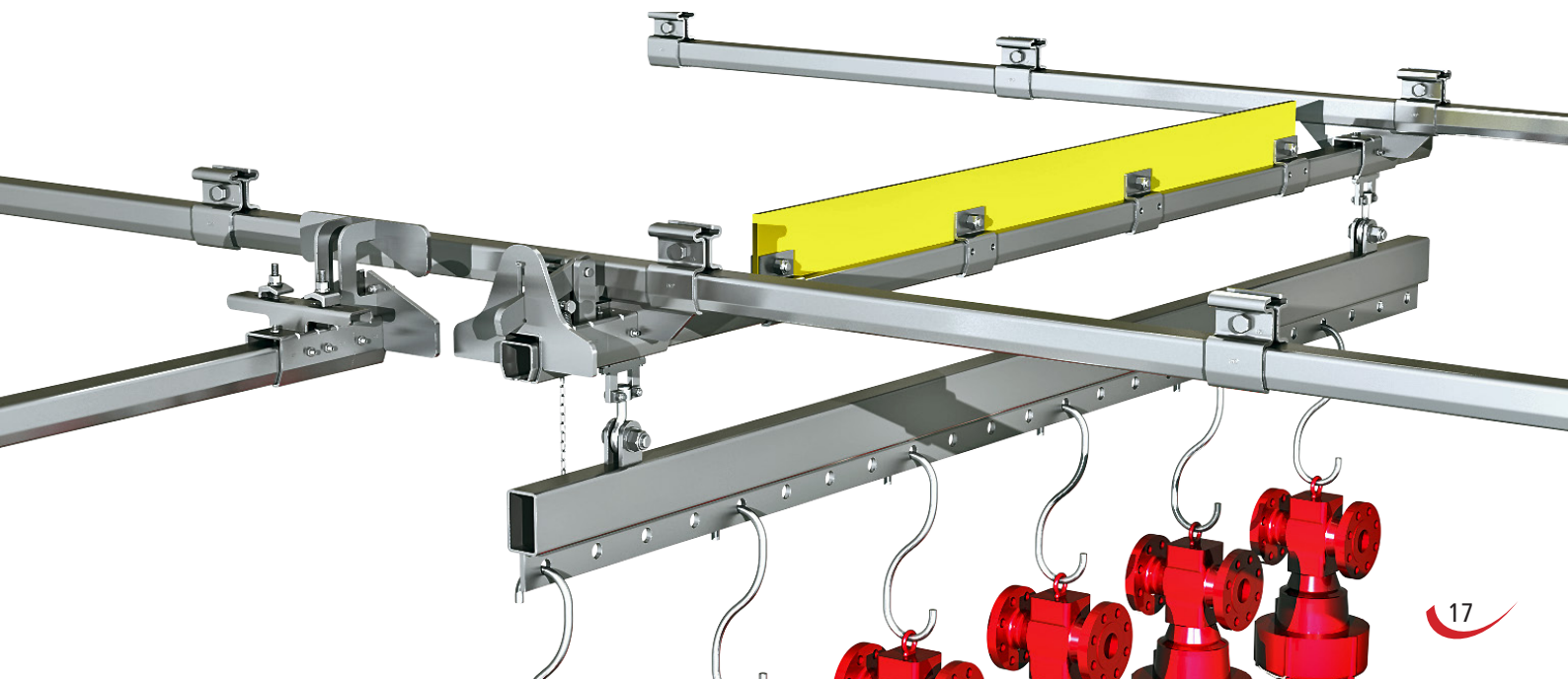

□	ref	kg	L	H	E
9040	9746S	150	416	63	135
9050	9756S	250	458	93	160
9060	9766S	500	501	120	205
9070	9776S	1000	614	158	220

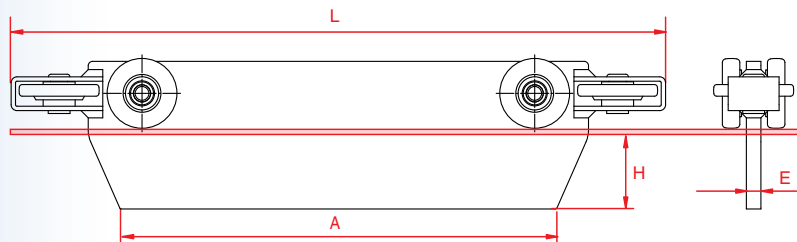
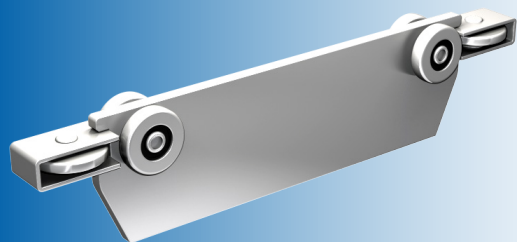

SOMMIER À SOUDER

 To be welded end crane trolleys /  Kranbahnrollapparat zum Anschweißen



	ref	kg	L	H	A	E
9040	9746SS	150	416	35	280	8
9050	9756SS	250	450	52	300	10
9060	9766SS	500	500	60	350	12
9070	9776SS	1000	600	60	390	12

SOMMIER À VISSER

 To be bolted end crane trolleys /  Kranbahnrollapparat zum Anschrauben

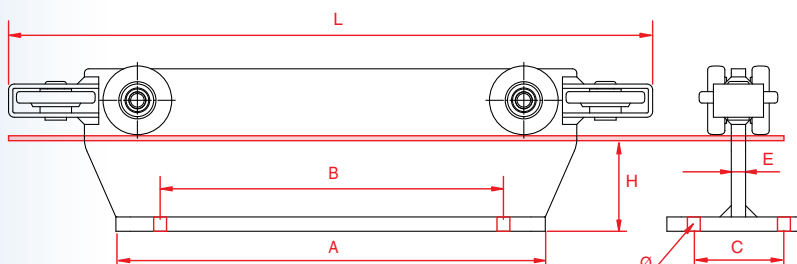
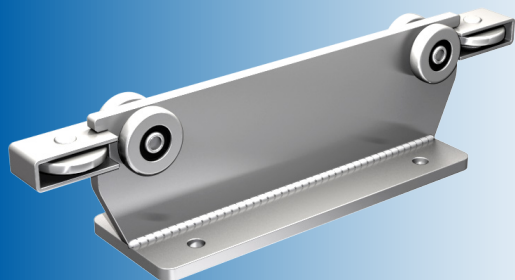



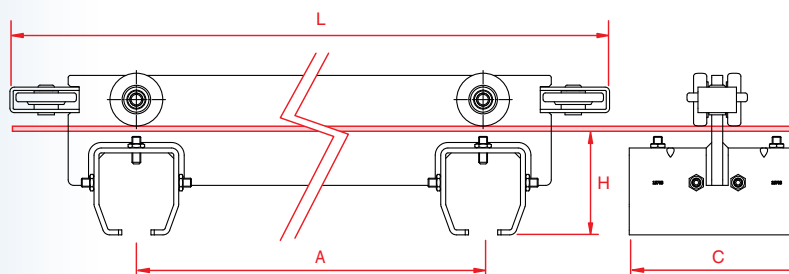

	ref	kg	L	H	A	B	C	Ø	E
9040	9746SV	150	416	45	280	220	46	11	8
9050	9756SV	250	450	64	300	220	60	13	10
9060	9766SV	500	500	70	350	260	80	17	12
9070	9776SV	1000	600	74	390	300	100	21	12

SOMMIER DOUBLE

 Double beam end crane trolleys /  Doppelt Kranbahnrollapparat



	ref	kg	L	H	A	C
9040	9746SD	150	700	74	500	135
9050	9756SD	250	730	91	500	160
9060	9766SD	500	860	126	600	205
9070	9776SD	1000	994	152	600	220

-  **TRANSBORDEURS**
-  **TRANSFER STATION**
-  **MEHRFACH KRANBAHN**



 **TRANSBORDEUR**

Un transbordeur est un pont multiple. Cet ensemble est composé de deux sommiers longs, de plusieurs poutres parallèles et d'un système de manipulation à poussée manuelle. Afin de transférer les pièces de manière sécurisée, le transbordeur s'indexe aux rails fixes à l'aide d'un doigt et bloque l'ensemble en position. Il faudra déverrouiller l'indexation afin de pouvoir repartir de la position.

 **TRANSFER STATION**

A transfer station is a multi rails crane. This set consists of two long end crane trolleys, several parallel beams and a manual push system. In order to transfer parts in secure manner the transfer station is indexed to fixed rails Using of a finger and all blocks in position. It will be necessary to unlock the index in order to leave the position.

 **MEHRFACH KRANBAHN**

Eine Mehrfahrkranbahn besteht aus zwei langen Schienen, mehreren parallelen Balken und einem manuellen Druckgerät. Um die Teile in Sicherheit zu bewegen, werden Verriegelungen eingebaut, sowie Sicherheitsmuffen.

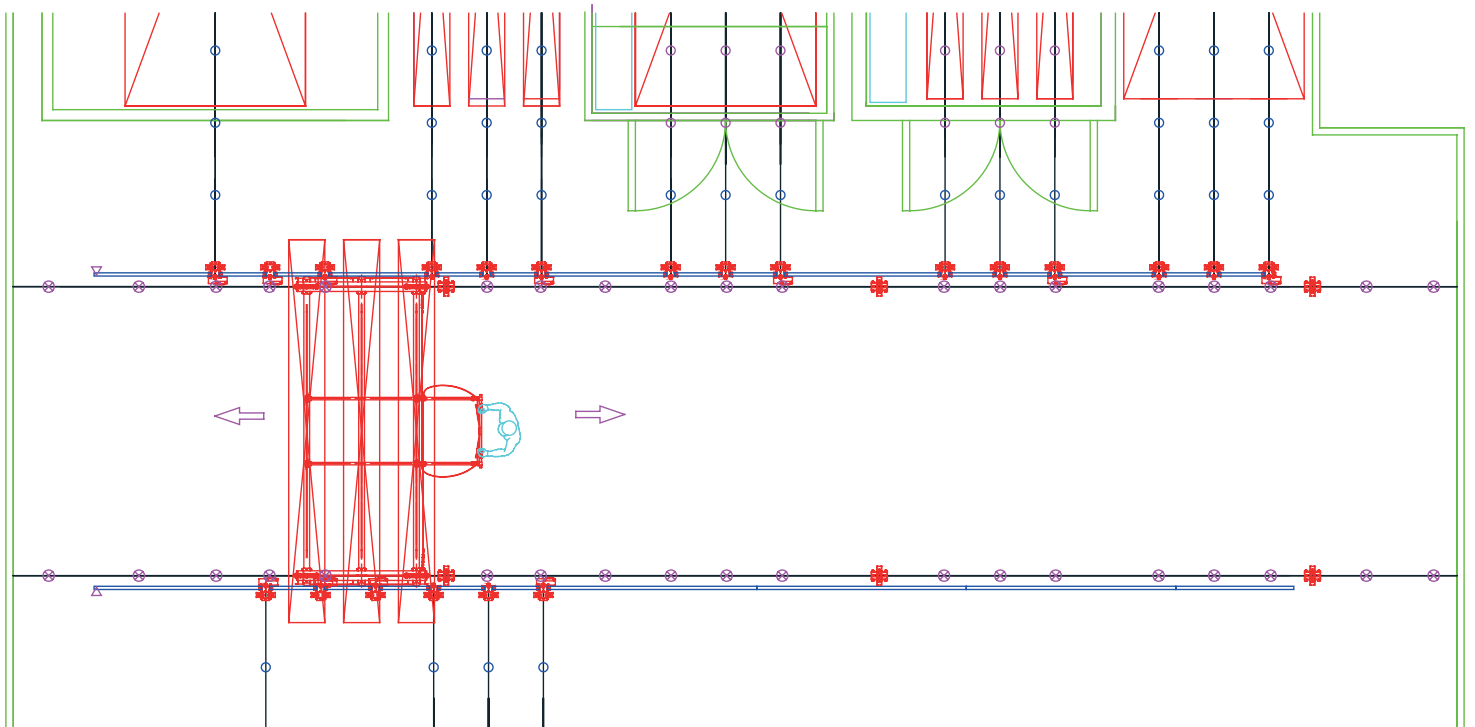



Poutres acier

Steel cranes / Kleinkrananlage aus Stahl

Plans sur demande

Drawings on demand

Zeichnung auf Anfrage

MANCHON DE SECURITÉ

Fixed locks without hanger
Sicherheitsmuffe

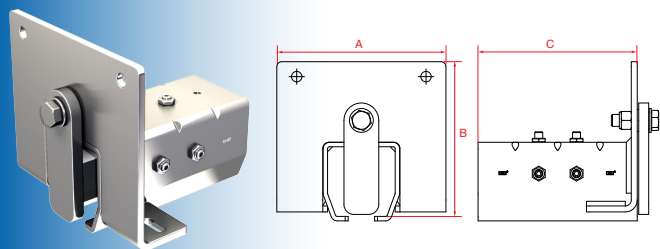

□	ref	A	B	C
9040	9401MSTB	170	132.5	135
9050	9501MSTB	170	155.5	160
9060	9601MSTB	190	175	205
9070	9701MSTB	220	213	220

SUPPORT MANCHON DE SECURITÉ

Fixed locks with hanger
Sicherheitsmuffe mit Aufhängung

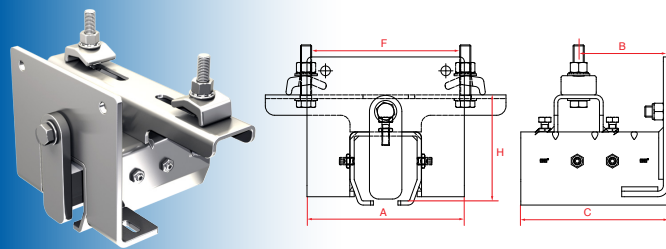

□	ref	A	B	C	H	F
9040	9401FMSTB	170	85	135	77	IPE 80 - 300
9050	9501FMSTB	170	97.5	160	114.5	IPE 80 - 300
9060	9601FMSTB	190	130	205	135	IPE 80 - 300
9070	9701FMSTB	220	145	220	200	IPE 80 - 300

VERROU GAUCHE DE TRANSBORDEUR

Left locking ramp
Verriegelung Links

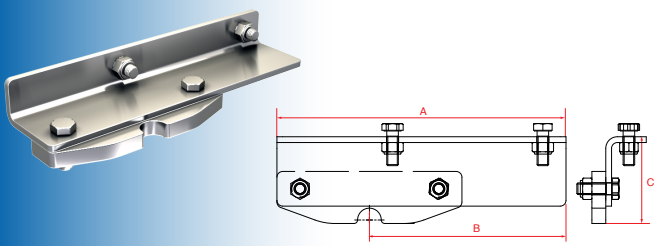

□	ref	A	B	C
9040	9401VGTB	250	85	66
9050	9501VGTB	250	85	75
9060	9601VGTB	260	85	110
9070	9701VGTB	260	85	110

VERROU DROIT DE TRANSBORDEUR

Right locking ramp
Verriegelung Rechts

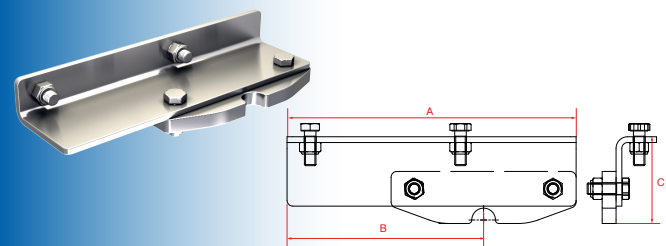

□	ref	A	B	C
9040	9401VDTB	250	85	66
9050	9501VDTB	250	85	75
9060	9601VDTB	260	85	110
9070	9701VDTB	260	85	110

CORNIÈRE DE TRANSBORDEUR

Security corners
Sicherheitswinkel

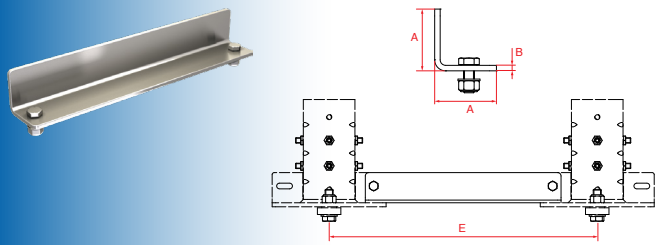

□	ref	A	B	E*
9040	9401CTBSP	40	4	*
9050	9501CTBSP	45	4	*
9060	9601CTBSP	45	4	*
9070	9701CTBSP	50	5	*

* Entraxe à spécifier lors de la commande

* specify spacing at order

* Abstand angeben bei der Bestellung



■ **FORMULAIRE TRANSBORDEUR** -  **TRANSFER STATION REQUEST** -  **SEITLICHE MITNAHME**

Date / Datum:

Client / Customer / Kunde:

Nom / Name / Namen:

Référence / Reference / Referenz :

Email:

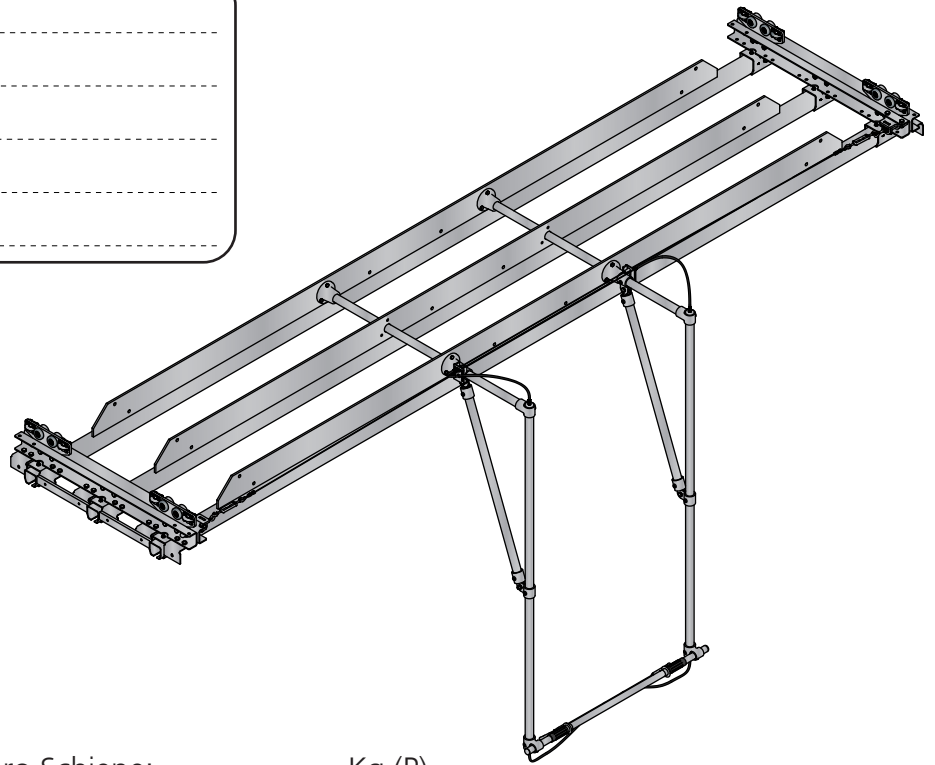

■ **DONNÉES TECHNIQUES**
 **TECHNICAL DATA**
 **TECHNISCHE DATEN**

Charge par rail / Load by track / Last pro Schiene: Kg (P)

Nombre de rail / Number of beams / Schiene Menge: (X)

Entraxe / Spacing / Abstand: mm (E)

Portée / Span / Länge: mm (L)

Profondeur / Distance / Tiefe: mm (D)

Hauteur / Height / Höhe: mm (H)

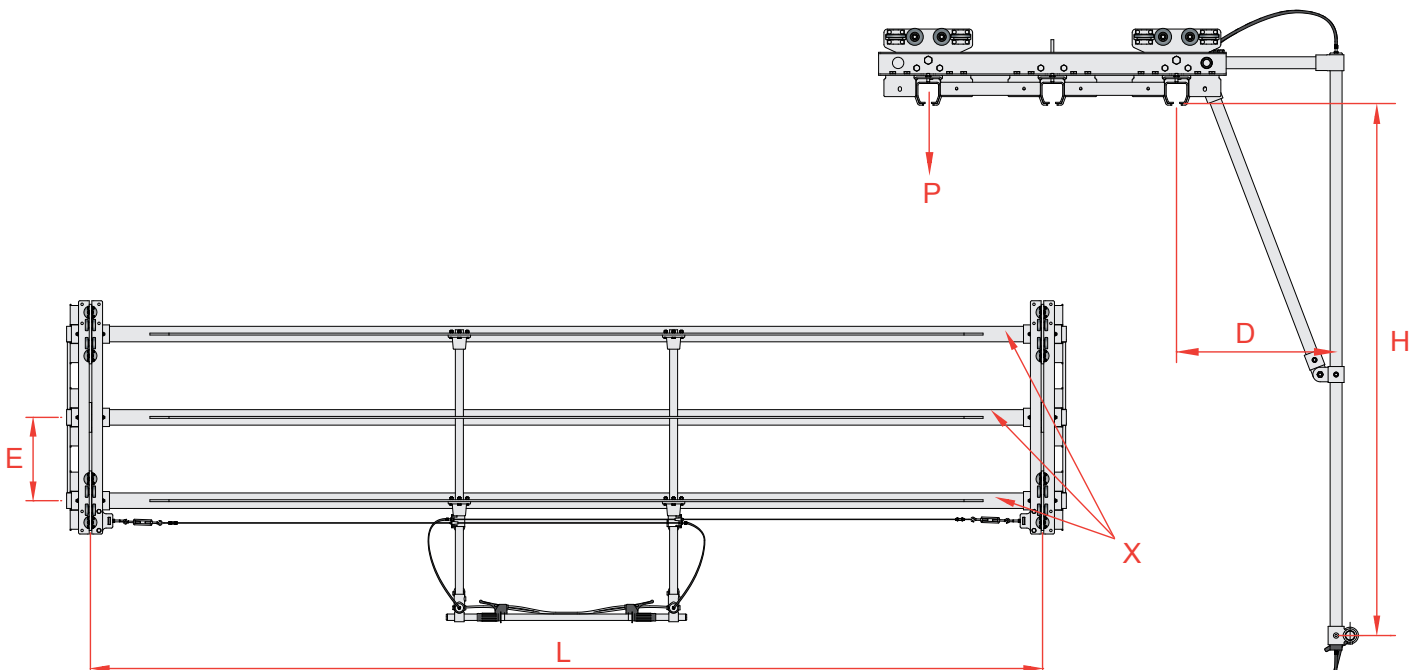



Poutres acier

Steel cranes / Kleinkrananlage aus Stahl

Plans sur demande

Drawings on demand

Zeichnung auf Anfrage

SUPPORT À SOUDER (ACIER BRUT)

Weld on brackets (plain steel)

Anschweissmuffe, Ausführung = blank

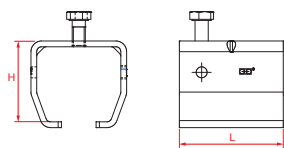

□	ref	H	L
9010	9018	33.5	40
9030	9038	39.5	54
9040	9048	49	63
9050	9058	74.5	75
9060	9068	89	110
9070	9078	124	110

SUPPORTS RÉGLABLES LW

LW adjustable support brackets

Verstellbare LW-Muffen

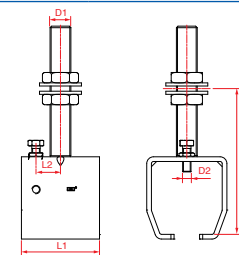

□	ref	D1	D2	L1	L2	H
9010	9011LW	M10	M6	40	20	85 ±30
9030	9031LW	M14	M6	54	29	97 ±30
9040	9041LW	M14	M8	63	31.5	105 ±25
9050	9051LW	M20	M8	75	37.5	140 ±30
9060	9061LW	M20	M10	110	55	155 ±25

SUPPORT À TIGE FILETÉE LONGUE

Long adjustable brackets

Höhenverstellbare Muffe lang

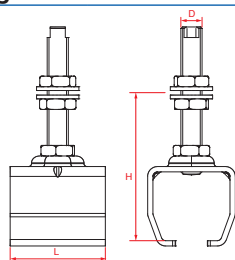

□	ref	D	L	H
9010	9011L	M10	40	85 ±30
9030	9031L	M14	54	97 ±30
9040	9041L	M14	63	105 ±30
9050	9051L	M20	75	140 ±30
9060	9061L	M20	110	155 ±30
9070	9071L	M30	110	238 ±25

SUPPORT PLAFOND

Roof fixing brackets

Deckenmuffe

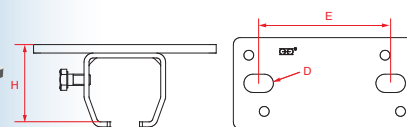

□	ref	D	E	H
9010	9018H	9	70	36.5
9030	9038H	11	81	43.5
9040	9048H	13	94	55
9050	9058H	17	125	81.5
9060	9068H	21	150	99
9070	9078H	21	163	136

SUPPORT PLAFOND AVEC VIS

Roof fixing brackets with bolt

Deckenmuffe

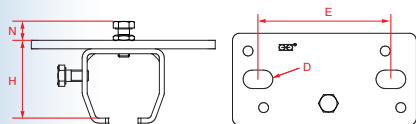

□	ref	H	N	E	D
9030	9038HP	43.5	12	81	11
9040	9048HP	55	14	94	13
9050	9058HP	81.5	14	125	17
9060	9068HP	99	22	150	21
9070	9078HP	136	22	163	21

PLATINE*

Roof fixing brackets*

Platten für Deckenmuffe*



ref	IPN Max	IPE Max
9038P	160	140
9048P	180	160
9058P	280	240
9068P	340	270
9078P	380	300

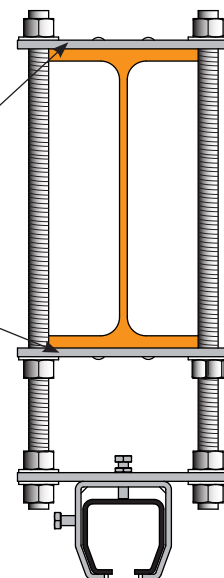

* tiges filetées non fournies / Threaded rods not furnished / Die Zuganker sind nicht mit geliefert



SUPPORT À SERRAGE NU

Clamping brackets
Klemm-Muffe

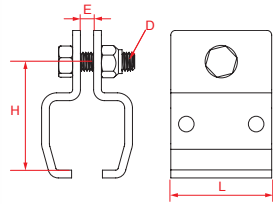

□	ref	D	E	L	H
9010	9012N	M10	6	40	49
9030	9032N	M12	8	54	59
9040	9042N	M12	8	65	70
9050	9052N	M16	10	90	89
9060	9062N	M16	10	110	104
9070	9072N	M16	10	110	142

SUPPORT

Brackets
Aufhängekombination

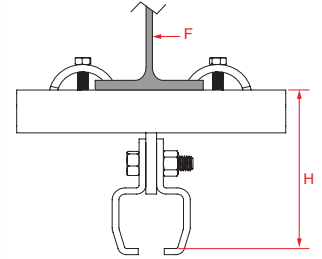

□	ref	H	F
9030	9037	119	IPE 80 - 240
9040	9047	130	IPE 80 - 240
9050	9057	168	IPE 80 - 240
9060	9067	204	IPE 80 - 240
9070	9077	242	IPE 80 - 240

SUPPORT SOUS POUTRELLE I

I beam brackets
Klemm-Muffe für IPE-Träger

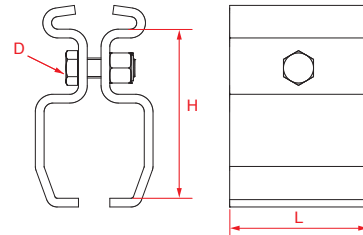

□	ref	D	L	H	IPN	IPE
9030	9037/80	M8	54	69	80	-
	9037/100	M8	54	69	100	80
	9037/120	M8	54	69	120	100
	9037/140	M8	54	69	140	120
9040	9047/80	M8	65	77	80	-
	9047/100	M8	65	77	100	80
	9047/120	M8	65	77	120	100
	9047/140	M8	65	77	140	120
	9047/160	M8	65	77	160	140
	9047/180	M8	65	77	180	160
	9047/200	M8	65	77	200	180
9050	9057/100	M16	90	115	100	80
	9057/120	M16	90	115	120	100
	9057/140	M16	90	115	140	120
	9057/160	M16	90	115	160	140
	9057/180	M16	90	115	180	160
9060	9067/140	M16	110	135	140	120
	9067/160	M16	110	135	160	140
	9067/180	M16	110	135	180	160
	9067/200	M16	110	135	200	180
9070	9077/200	M16	110	200	200	180



Poutres acier

Steel cranes / Kleinkrananlage aus Stahl

Plans sur demande
Drawings on demand
Zeichnung auf Anfrage

MANCHON DE RACCORDEMENT

Jointing brackets / Verbindungsmuffe

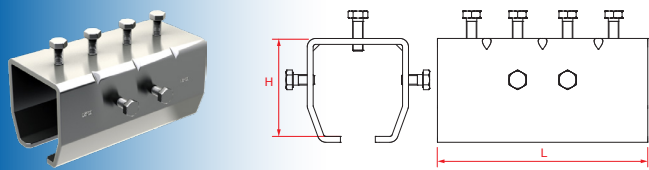

	ref	H	L
9010	9011M	33.5	90
9030	9031M	39.5	115
9040	9041M	49	135
9050	9051M	74.5	160
9060	9061M	89	205
9070	9071M	124	220

MANCHON À VIS HC CUVETÉES

Jointing brackets
 Verbindungsmuffe mit HC Schraube

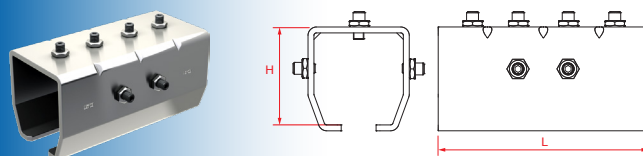

	ref	H	L
9030	9031MHC	39.5	115
9040	9041MHC	49	135
9050	9051MHC	74.5	160
9060	9061MHC	89	205
9070	9071MHC	124	220

MANCHON À TIGE FILETÉE COURTE

Jointing brackets with short bolt
 Höhenverstellbare Verbindungsmuffe Kurze Bolzen

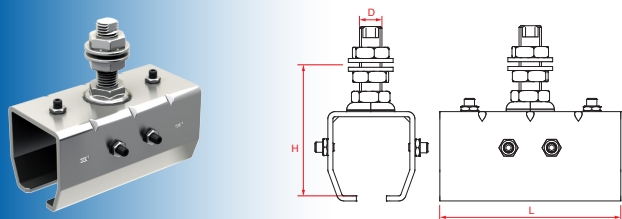

	ref	D	H	L
9040	9041MC	M14	80 ±5	135
9050	9051MC	M20	112 ±5	160
9060	9061MC	M20	127 ±5	205

MANCHON À TIGE FILETÉE LONGUE

Jointing brackets with long bolt
 Höhenverstellbare Verbindungsmuffe Lang Bolzen

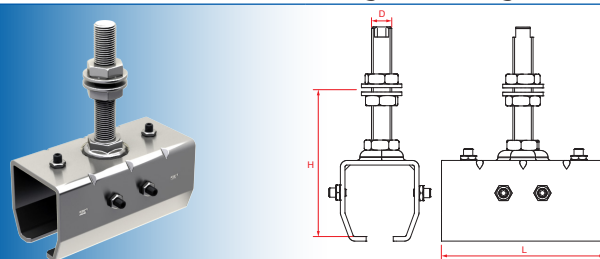

	ref	D	H	L
9030	9031ML	M14	97 ±30	115
9040	9041ML	M14	105 ±30	135
9050	9051ML	M20	140 ±35	160
9060	9061ML	M20	155 ±30	205

MANCHON SUPPORT

Roof jointing brackets
 Deckerverbindungsmuffe

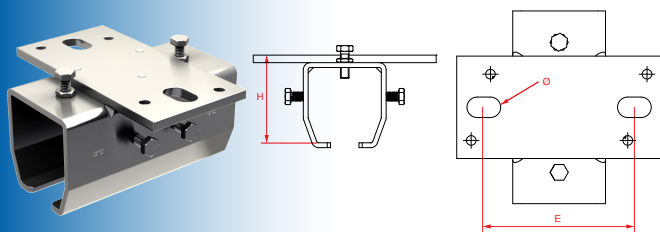

	ref	H	E	Ø
9030	9031MH	43.5	81	11
9040	9041MH	55	94	13
9050	9051MH	81.5	125	17
9060	9061MH	99	150	21
9070	9071MH	136	163	21

PLATINE*

Roof fixing brackets*
 Platten für Deckenmuffe*



ref	IPN Max	IPE Max
9038P	160	140
9048P	180	160
9058P	280	240
9068P	340	270
9078P	380	300

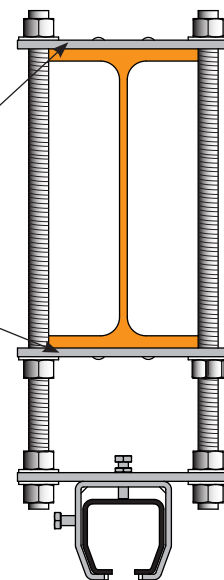

* tiges filetées non fournies Threaded rods not furnished Die Zuganker sind nicht mit Geliefert

SUPPORT DE JONCTION PERPENDICULAIRE

Perpendicular jointing brackets
Muffe mit Trägerplatte Quer

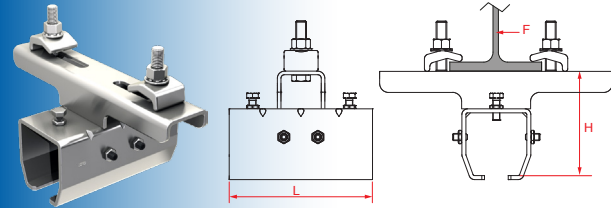

□	ref	H	L	F
9030	9037FMP	69	115	IPE 80 - 300
9040	9047FMP	77	135	IPE 80 - 300
9050	9057FMP	115	160	IPE 80 - 300
9060	9067FMP	135	205	IPE 80 - 300
9070	9077FMP	200	220	IPE 80 - 300

SUPPORT DE JONCTION EN LIGNE

In line jointing brackets
Muffe mit Trägerplatte Lang

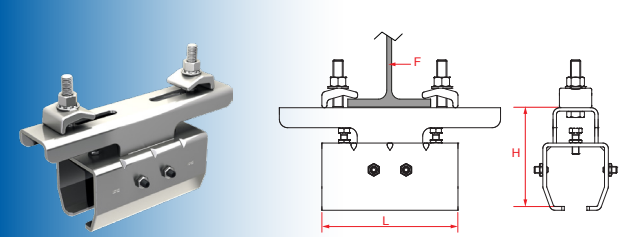

□	ref	H	L	F
9050	9057FML	115	160	IPE 80 - 300
9060	9067FML	135	205	IPE 80 - 300
9070	9077FML	200	220	IPE 80 - 300

SUPPORT DE FIXATION SOUS POUTRELLE I

Under I beam clamps
Klemm-Muffe für IPE-Träger

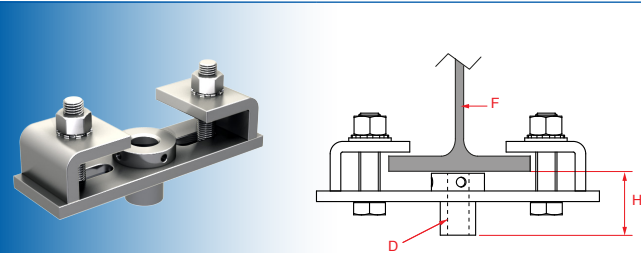

□	ref	D	H	F
9010	3537	M10	35	IPE 80 - 160
9030 / 9040	6262	M14	35	IPE 80 - 160
9050 / 9060	8577	M20	40	IPE 80 - 160

SUPPORT DE FIXATION SOUS POUTRELLE I LARGE

Under large I beam clamps
Befestigungsträger an IPE-Träger, Lang

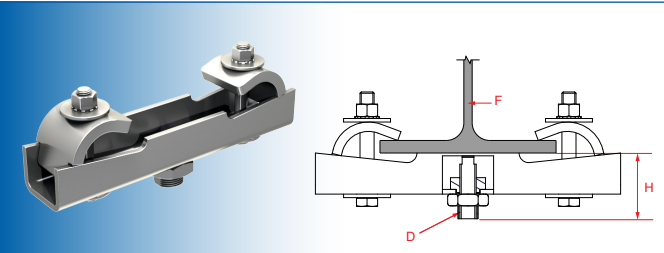

□	ref	D	H	F
9030 / 9040	9000TPV	M14	56	IPE 100 - 300
9030 / 9040	9000TPLV	M14	61	IPE 300 - 600
9050 / 9060	9000TPVR	M20	65	IPE 100 - 300
9050 / 9060	9000TPLVR	M20	65	IPE 300 - 600

Supports sous IPE / IPN utilisables avec supports à tige filetée page 22 et manchons à tige filetée page 24.

Under IPE / IPN hangers, used with threaded rod hangers page 22 threaded rod sleeves and page 24.

IPE/ IPN Träger können mit höhenverstellbaren Muffen S. 22 oder höhenverstellbaren Verbindungsmuffen S. 24 verwendet werden.

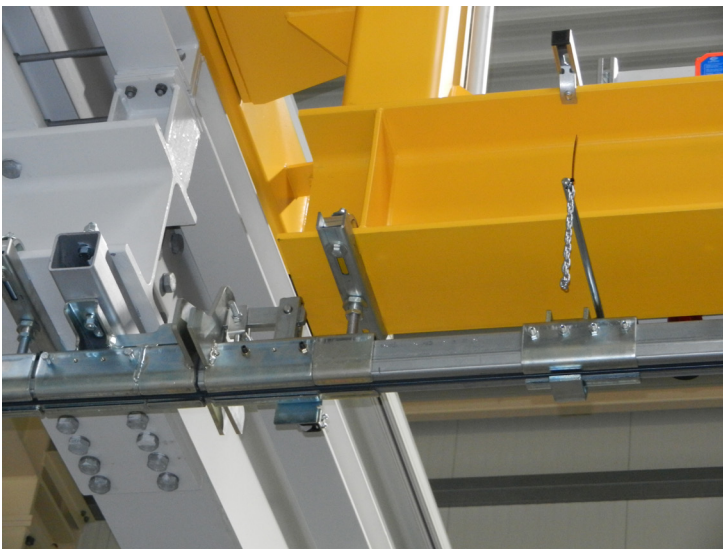

Chandelle inclinable
Inclined hangers / Zugankern

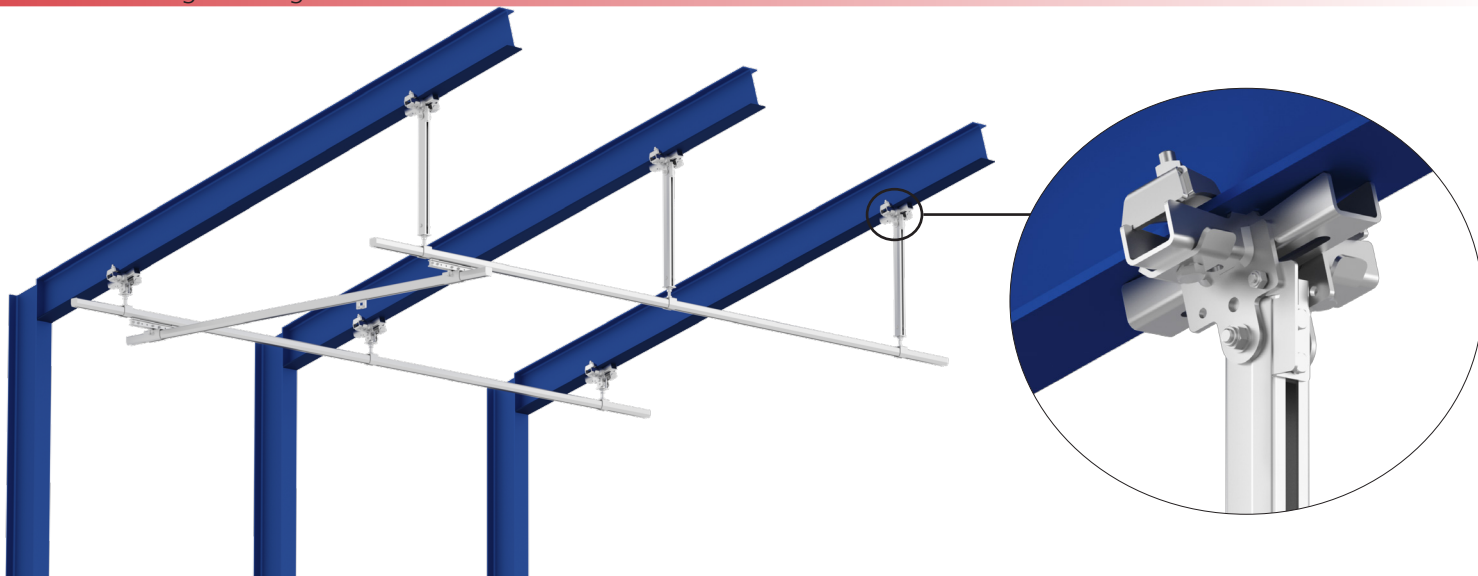

■ ■ CHANDELLE COURTE

■ ■ Short hanger / ■ ■ Kurze Aufhängungen

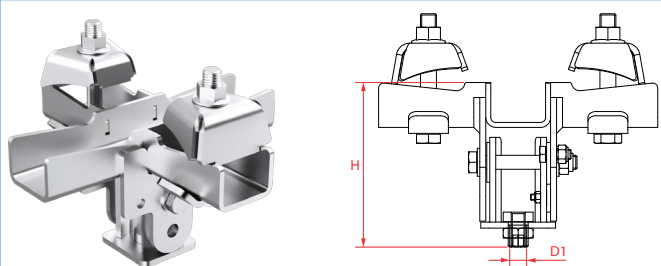

□	ref	H (mm)	D1	IPE ⊥ *	IPE // *
9040	9048CC	165	M14	80 - 300	200 - 300
9050	9058CC	170	M20	80 - 300	200 - 300
9060	9068CC	170	M20	80 - 300	200 - 300

■ ■ CHANDELLE COURTE

■ ■ Short hanger / ■ ■ Kurze Aufhängungen

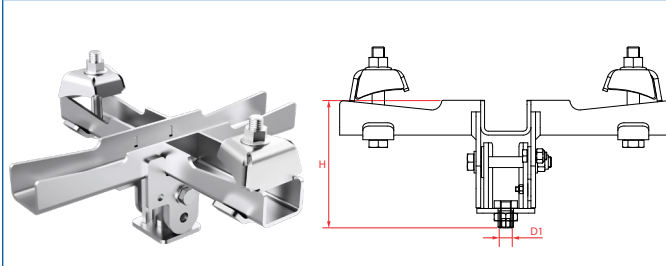

□	ref	H (mm)	D1	IPE ⊥ *	IPE // *
9040	9148CC	165	M14	300 - 600	300 - 600
9050	9158CC	170	M20	300 - 600	300 - 600
9060	9168CC	170	M20	300 - 600	300 - 600

* ⊥ ■ ■ Perpendiculaire à la voie de roulement ■ ■ Perpendicular to the running way ■ ■ Quer zur Laufbahn
 * // ■ ■ Parallèle à la voie de roulement ■ ■ Parallel to the running way ■ ■ Parallel zur Laufbahn

■ ■ CHANDELLE LONGUEUR SPÉCIALE

■ ■ Special length hanger / ■ ■ Lange Aufhängungen

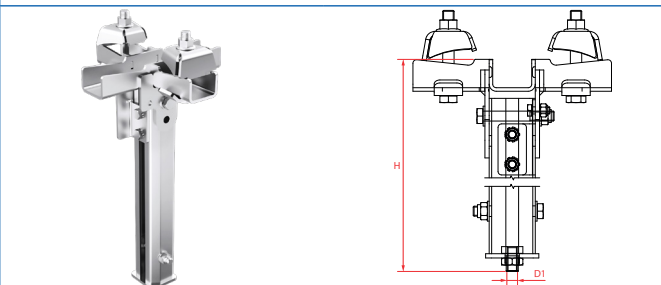

□	ref	H (mm)	D1	IPE ⊥ *	IPE // *
9040	9048CLSP	xx	M14	80 - 300	200 - 300
9050	9058CLSP	xx	M20	80 - 300	200 - 300
9060	9068CLSP	xx	M20	80 - 300	200 - 300

■ ■ CHANDELLE LONGUEUR SPÉCIALE

■ ■ Special length hanger / ■ ■ Lange Aufhängungen

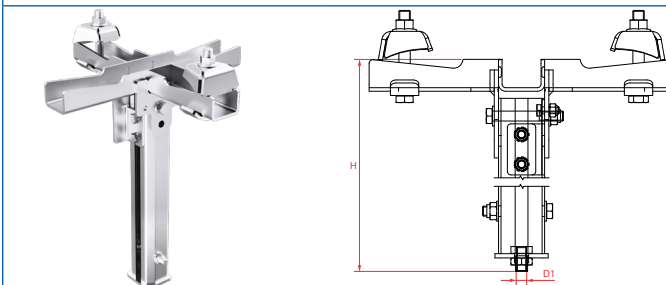

□	ref	H (mm)	D1	IPE ⊥ *	IPE // *
9040	9148CLSP	xx	M14	300 - 600	300 - 600
9050	9158CLSP	xx	M20	300 - 600	300 - 600
9060	9168CLSP	xx	M20	300 - 600	300 - 600

* ⊥ ■ ■ Perpendiculaire à la voie de roulement ■ ■ Perpendicular to the running way ■ ■ Quer zur Laufbahn
 * // ■ ■ Parallèle à la voie de roulement ■ ■ Parallel to the running way ■ ■ Parallel zur Laufbahn

■ ■ CHANDELLE À COMPOSER

To be composed hanger / Kombinationsmöglichkeiten eines Zugankers

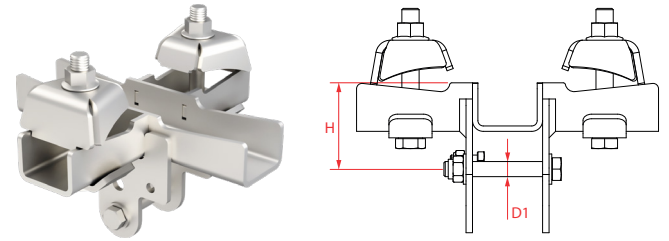

	ref	H	D1	IPE ⊥ *	IPE // *
9040					
9050	30310CH	80	M14	80 - 300	200 - 300
9060					

* ⊥ Perpendiculaire à la voie de roulement
 Perpendicular to the running way
 Quer zur Laufbahn

■ ■ CHANDELLE À COMPOSER

To be composed hanger / Kombinationsmöglichkeiten eines Zugankers

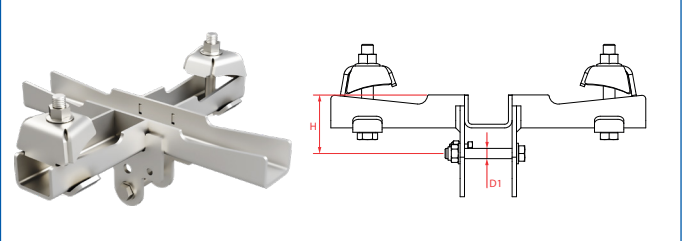

	ref	H	D1	IPE ⊥ *	IPE // *
9040					
9050	30310LCH	80	M14	300 - 600	300 - 600
9060					

* // Parallèle à la voie de roulement
 Parallel to the running way
 Parallel zur Laufbahn



Profil acier 9050
9050 Steel profil
9050 Edelstahl Schienenprofil

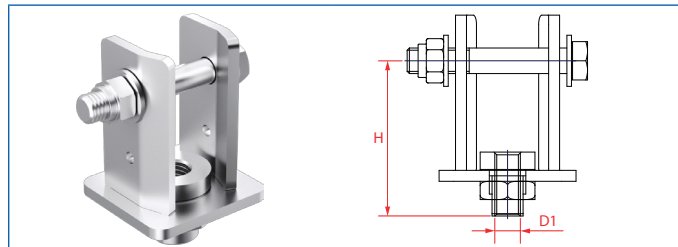

	ref	H	D1
9040	9047CB	85	M14
9050	9057CB	90	M20
9060	9067CB	90	M20

Anti rotation + Triangulation + Gabarit de perçage

Anti rotating + stabilisation + Drilling template / Stabilisierung + Dreiecksaufnahme + Bohrschablone

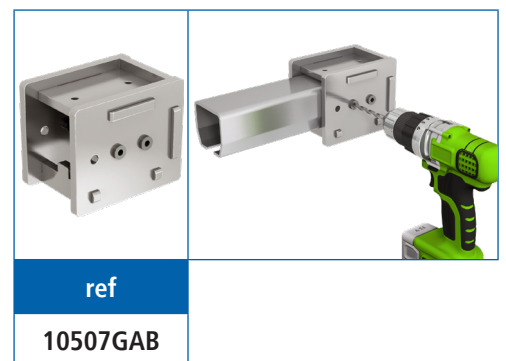
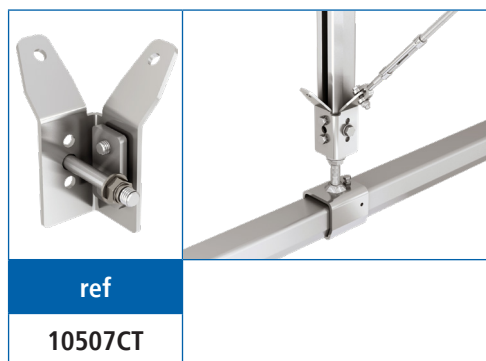

Chandelle plafond béton
Concrete roof hangers / Zuganker für Betondecke

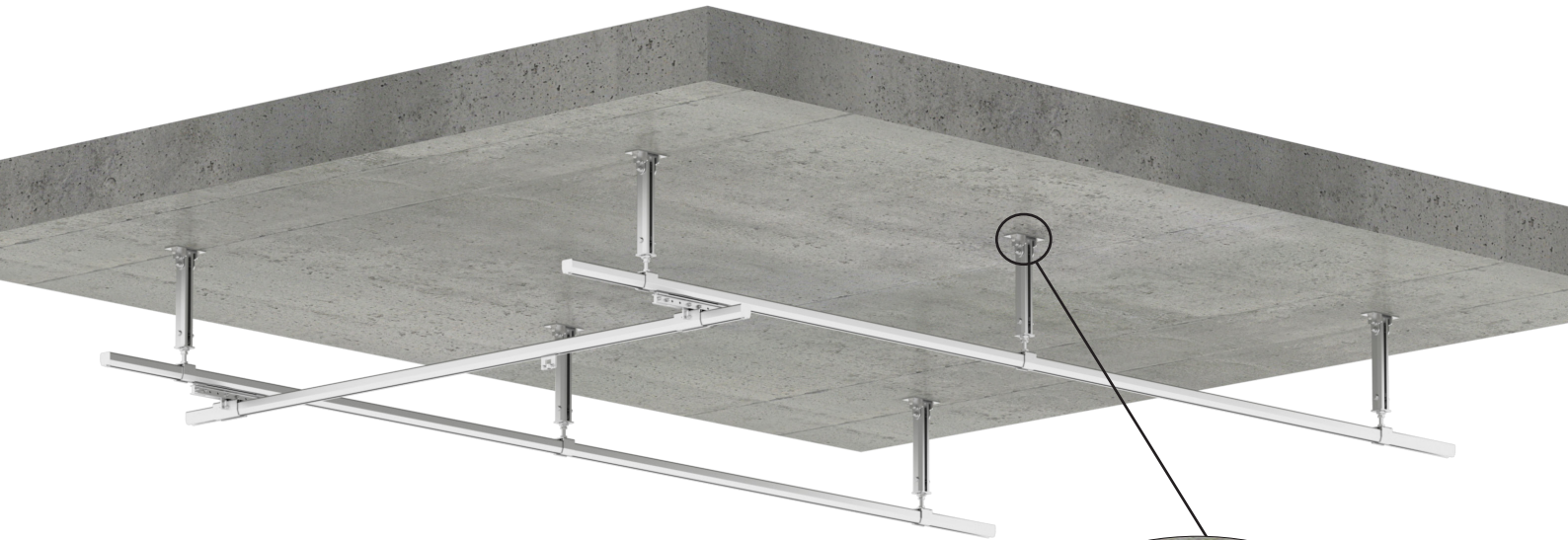

■ ■ CHANDELLE PLAFOND LONGUEUR SPÉCIALE
 ■ ■ Special length roof hanger / ■ ■ Lange Aufhängungen

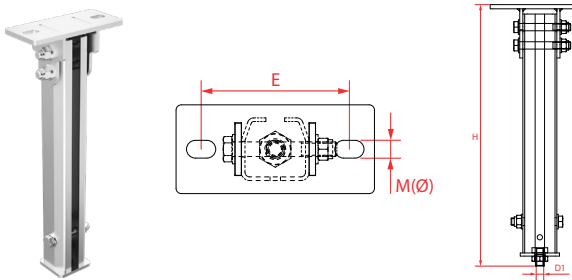

□	ref	H* (mm)	D1	M (Ø)	E (mm)
	9040 9046CLSP	xx	M14	17	142
	9050 9056CLSP	xx	M20	17	142
	9060 9066CLSP	xx	M20	21	160

■ ■ * Cote à préciser à la commande
 ■ ■ Specify dimension when ordering
 ■ ■ Genaue Maße bei der Bestellung angeben

Triangulation + Gabarit de perçage
Stabilisation + Drilling template / Stabilisierung + Bohrschablone



ref

10507CT



ref

10507GAB

NB : Chevilles plafond non fournies / Ceiling anchors not supplied / Deckenanker im Lieferumfang nicht enthalten



CHANDELLE À COMPOSER

UK To be composed hanger / DE Kombinationsmöglichkeiten eines Zugankers

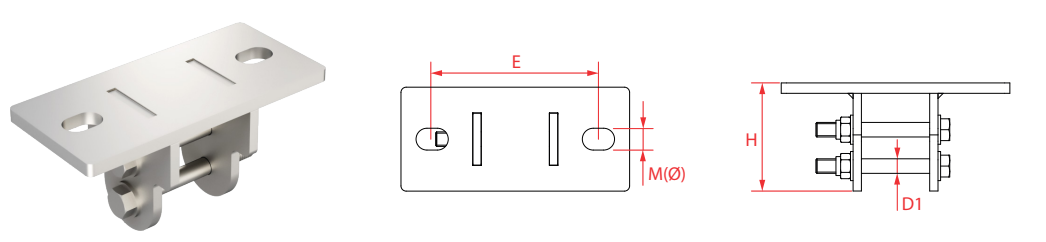

□	ref	H (mm)	D1	M (Ø)	E (mm)
9040 9050	10506CH	78	M14	17	142
9060	10606CH	80	M14	21	160



Profil acier 9050
9050 Steel profil
9050 Edelstahl Schienenprofil

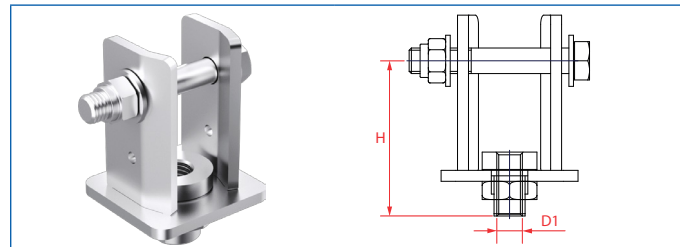

□	ref	H	D1
9040	9047CB	85	M14
9050	9057CB	90	M20
9060	9067CB	90	M20

Inox
Stainless steel / Edelstahl

Pour une version inox, veuillez nous consulter.
For a stainless steel version, please contact us.
Für eine Ausführung in Edelstahl, kontaktieren Sie uns bitte.



CHARGES MAXI ADMISSIBLES PAR SUSPENTE

Maximum allowable loads by hanger

Max. Zulässige Last pro Zuganker

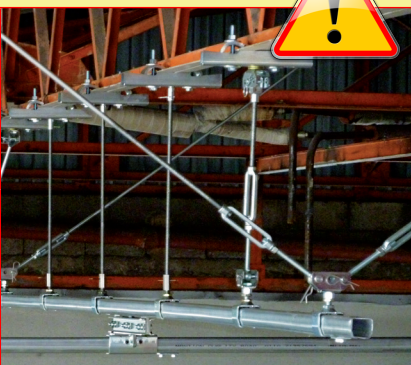
9030	40 daN	
9040	150 daN	
9050	250 daN	
9060	500 daN	

TIRANT

Threaded rod / Zuganker

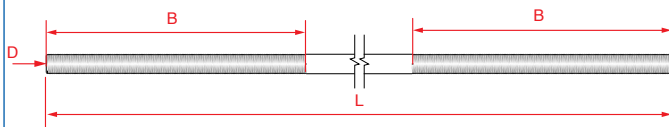

Ref	L	D	B
9000T/50	500	M12	500
9000T/100	1000	M12	300
9000T/150	1500	M12	300
9000T/200	2000	M12	300
9000T/250	2500	M12	300
9000T/300	3000	M12	300

SUPPORT À ÉCROU

Nut hanger / Aufhänger mit Mutter

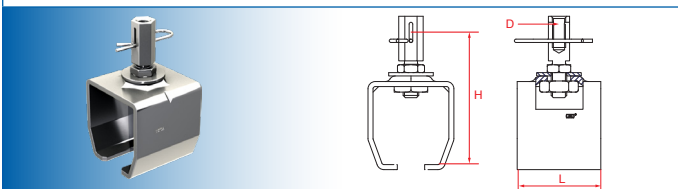

ref	D	H	L	
9030	9031TE	M12	93.5 ±7	54
9040	9041TE	M12	102 ±7	63
9050	9051TE	M12	118.5 ±7	75
9060	9061TE	M12	133.5 ±7	110

SUPPORT ARTICULÉ

Articulated hanger / Aufhängung mit Drehgelenk

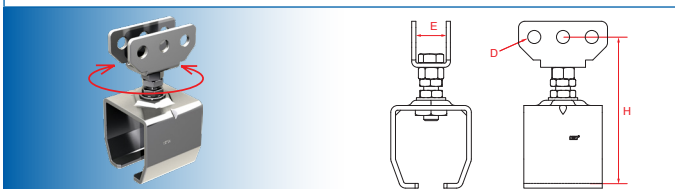

ref	D	H	E	
9030	9031TEA	12.5	111	29
9040	9041TEA	12.5	120	29
9050	9051TEA	12.5	140	29
9060	9061TEA	12.5	155	29

SUPPORT PLAFOND À ROTULE

Roof ball hanger
Decken-Aufhängung mit Kugelgelenk

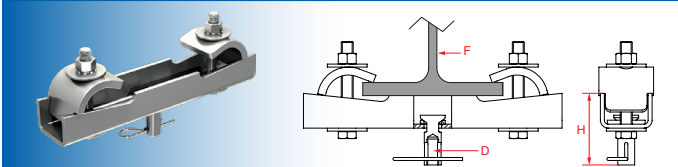

ref	D	H	F	
9030 → 9050	9000TPR	M12	72	IPE 100 - 300
9060	9000TPRR	M12	76	IPE 100 - 300

SUPPORT PLAFOND À CHAPE

Articulated roof hanger
Decken-Aufhängung mit Gabelkopf

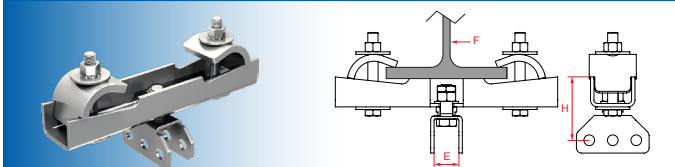

ref	D	H	F	
9030 → 9050	9000TPC	29	74	IPE 100 - 300
9060	9000TPCR	29	79	IPE 100 - 300

SUPPORT PLAFOND NU

Nude roof hanger / Decken-Aufhängung, einfach

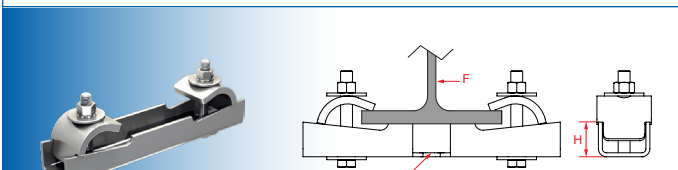

ref	D	H	F	
9030 → 9050	9000TPN	17.5	35	IPE 100 - 300
9060	9000TPNR	17.5	40	IPE 100 - 300

SUPPORT PLAFOND RALLONGÉ NU

Long nude Roof hanger
Verlängerte Decken-Aufhängung, einfach

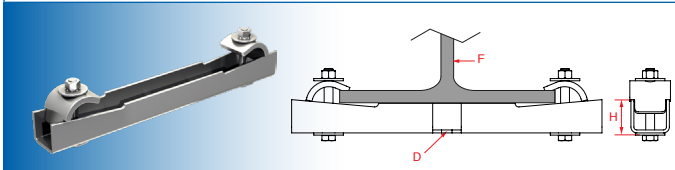

ref	D	H	F	
9030 → 9050	9000TPL	17.5	40	IPE 300 - 600
9060	9000TPLR	17.5	40	IPE 300 - 600

CHAPE FEMELLE

🇬🇧 Rod clevis / 🇩🇪 Gabelkopf mit Innengewinde

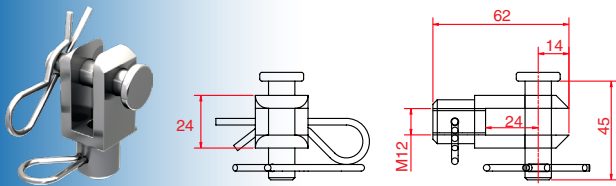

ref

9030 → 9060

9000TCF

CHAPE MÂLE

🇬🇧 Rod eye / 🇩🇪 Gabelkopf mit Außengewinde

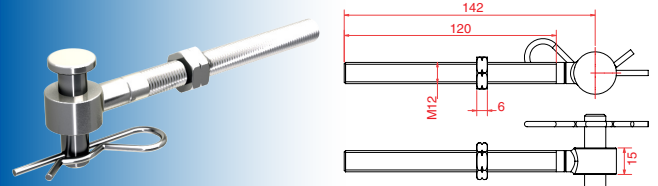

ref

9030 → 9060

9000TCM

ACCOUPEMENT

🇬🇧 Coupling / 🇩🇪 Kupplung

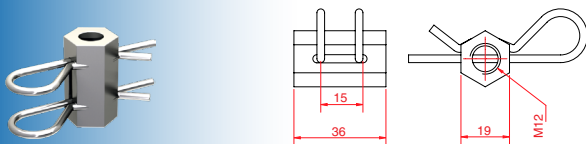

ref

9030 → 9060

9000TM

LANTERNE

🇬🇧 Tensioner / 🇩🇪 Seilspanner

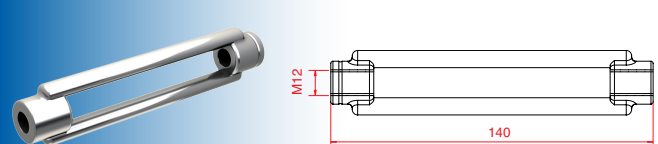

ref

9030 → 9060

9000TL

ÉCROU À ROTULE

🇬🇧 Nut ball / 🇩🇪 Mutter mit Kugelgelenk

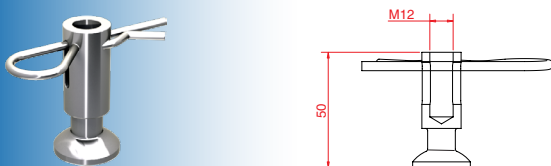

ref

9030 → 9060

10501ER

ÉTRIER ARTICULÉ

🇬🇧 articulated bracket / 🇩🇪 Bügel mit Gelenk

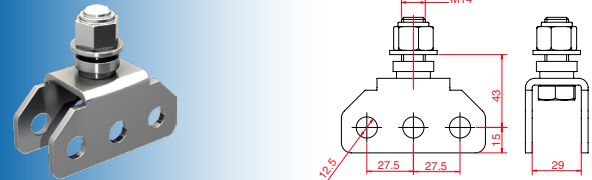

ref

9030 → 9060

9000TEA

GABARIT DE PERÇAGE

🇬🇧 Drilling template / 🇩🇪 Bohrschablone

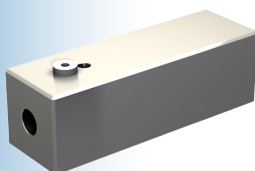

ref

9030 → 9060

9000TGP



■ Gabarit de perçage à utiliser pour percer l'extrémité des tirants M12 pour mise en place des goupilles beta de sécurité.

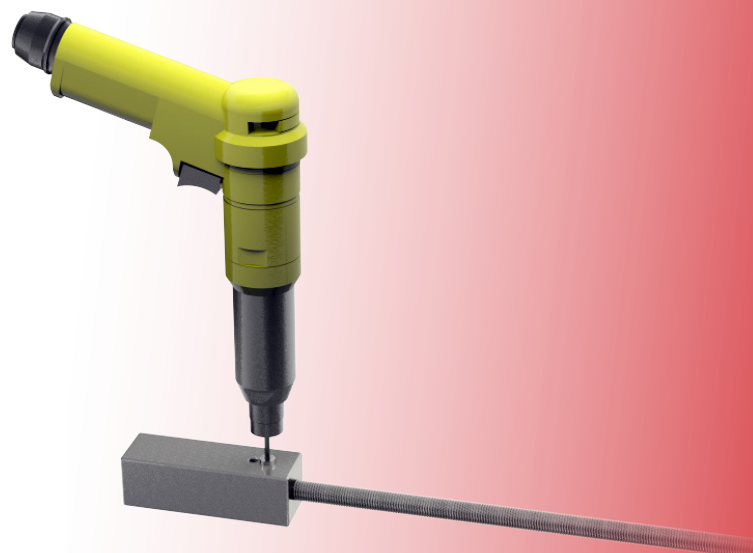

🇬🇧 Use this drilling template to drill the ends of the M12 rods for implementation of safety pins.

🇩🇪 Diese Bohrschablone wird verwendet, um das Ende der M12 Zuganker zum Einsetzen von Sicherungssplinten aufzubohren.





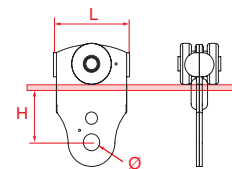

 Désignation  Description  Beschreibung		ref				Ø	H	L
--	---	-----	---	---	--	---	---	---

	CHARIOTS ARMATURE ACIER								
	 Trolleys Steel body	9010	99711	5	d	l	10	29	36
	 Transporthänger Stahl	9010	9711	10	a	b	10	29	36
		9030	99731	10	d	l	10	32.5	50
		9030	9731	20	a	b	10	32.5	50
		9030	9731N	13	bn	b	10	32.5	50
		9040	99741	20	d	l	14	45	65
		9040	9741	35	a	b	14	45	65
		9040	9741S	50	a	bp	14	45	65
	9040	9741N	25	bn	b	14	45	65	



	CHARIOTS ARMATURE ACIER								
	 Trolleys Steel body	9010	99712	10	d	l	8,5	38	90
	 Transporthänger Stahl	9010	9712	20	a	b	8,5	38	90
		9030	99732	20	d	bz	8,5	34	89
		9030	9732	40	a	b	8,5	34	89
		9030	9732N	25	bn	bp	8,5	34	89
		9040	99742	35	d	l	14	43	118
		9040	9742	70	a	b	14	43	118
		9040	9742S	100	a	bp	14	43	118
		9040	9742N	50	bn	bp	14	43	118
		9050	99752	80	d	l	14	39	156
		9050	9752	160	a	b	14	39	156
		9050	9752S	200	a	bp	14	39	156
		9050	9752N	100	bn	bp	14	39	156
	9060	99762	160	d	l	14	32	156	
	9060	9762S	400	a	bp	14	32	156	

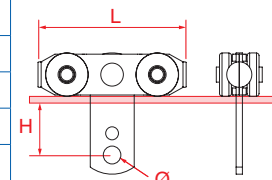

CHARGE PORTANTE DES CHARIOTS

Charge portante des chariots

Dans les tableaux des chariots, les forces maxi sont indiquées. Pour calculer la charge réelle admissible F, la force utile doit être divisée par le coefficient alpha.

F = Force / alpha

Max load on trolleys

In the tables of the trolleys, the maximum load is indicated. To calculate the real load F, the load must be divided by the alpha parameter.

F = load / alpha

Tragkraft der Transporthänger

In der Tabelle wird die maximale Tragkraft angegeben. Um die höchstzulässige Tragkraft F zu errechnen, muss die Kraft durch den Koeffizienten alpha dividiert werden.

F = Kraft / alpha

Type	alpha
 utilisation normale pas de chocs (déplacement manuel, 5 h par jour)  normal use without shocks (manual hand drive, 5 h per day)  normale Nutzung ohne Erschütterung (manuelle Bewegung, 5 h pro Tag)	1
 utilisation normale avec chocs légers (déplacement manuel, 10 h par jour)  normal use with light shocks (manual hand drive, 10 h per day)  normale Nutzung mit leichter Erschütterung (manuelle Bewegung, 10 h pro Tag)	1.2
 utilisation fréquente avec chocs légers (déplacement manuel, 16 h par jour)  frequent use with light shocks (manual hand drive, 16 h per day)  häufige Nutzung mit leichter Erschütterung (manuelle Bewegung, 16 h pro Tag)	1.3
 utilisation intensive avec chocs ou installation automatique (16 h par jour)  intensive use with shocks or automatic installation (16 h per day)  intensive Nutzung mit Erschütterung oder automatischer Installation (16 h pro Tag)	2



 Galets : d = delrin / a = acier / bn = billes + bandage nylon  Roller : d = delrin / a = steel / bn = ball bearing + nylon ring  Rollen : d = Delrin / a = Stahl / bn = Kugellager mit Nylonauffläche	 Paliers : bz = bronze / l = lisse / b = billes / bp = billes de précision  Axle : bz = bronze / l = smooth axle / b = ball bearing / bp = precision ball  Lager : bz = Bronze / l = Flachachse / b = Kugellager / bp = Präzisionskugellager
--	--

Désignation Description Beschreibung	ref	kg			Ø	H	L		
■ ■ CHARIOTS									
	Trolleys Transporthänger	9040 9742SP	100	a	bp	14	48	120	
		9050 9752SP	200	a	bp	14	41	120	
		9060 9762SP	400	a	bp	16	49	145	
■ ■ CHARIOTS									
	Trolleys Transporthänger	9040 9742RS	100	a	bp	14	30	89	
		9050 9752RS	200	a	bp	18	43	128	
		9060 9762RS	400	a	bp	20	46	158	
■ ■ CHARIOTS À ROTULE ARMATURE ACIER									
	Trolleys with ball Transporthänger mit Kugelgelenk	9030 9831RT	20	a	b	M12	75	70	
		9040 9841RT	35	a	bp	M16	81	80	
		9050 9851SRT	100	a	bp	M20	107	100	
		9060 9861SRT	200	a	bp	M24	129	120	
■ ■ CHARIOTS À ROTULE ARMATURE ACIER									
	Trolleys with ball Transporthänger mit Kugelgelenk	9030 9832RT	40	a	b	M12	75	70	
		9040 9842RT	70	a	bp	M16	81	90	
		9050 9852SRT	200	a	bp	M20	107	110	
		9060 9862SRT	400	a	bp	M24	129	140	
■ ■ CHARIOTS ARMATURE ACIER									
	Trolleys Steel body Transporthänger Stahl	9010 99812	10	d	l	10.5	18	90	
		9010 9812	20	a	b	10.5	18	90	
		9030 99832	20	d	l	12.5	22	89	
		9030 9832	40	a	b	12.5	22	89	
		9030 9832N	25	bn	bp	12.5	22	89	
		9040 99842	35	d	l	15	23	118	
		9040 9842	70	a	b	15	23	118	
		9040 9842S	100	a	bp	15	23	118	
		9040 9842N	50	bn	bp	15	23	118	
		9050 99852	80	d	l	17	35	156	
		9050 9852	160	a	b	17	35	156	
		9050 9852S	200	a	bp	17	35	156	
		9050 9852N	100	bn	b	17	35	156	
		9060 99862	160	d	l	17	28	156	
		9060 9862S	400	a	bp	21	28	156	
■ ■ CHARIOTS ARMATURE ACIER									
	Trolleys Steel body Transporthänger Stahl	9040 9842SP	150	a	bp	14.5	32	98	
		9050 9852SP	250	a	bp	16.5	42	128	
		9060 9862SP	500	a	bp	21	47	158	
		9070 9872SP	1000	a	bp	31	44	223	
■ ■ CHARIOTS HAUTE TEMPÉRATURE									
MAX 250°									
	High temperature Trolleys Transporthänger für Hochtemperatur	9040 9842HT	150	a	b	14	32	98	
		9050 9852HT	250	a	b	16.5	42	128	
		9060 9862HT	500	a	b	21	47	158	

Galets : d = delrin / a = acier / bn = billes + bandage nylon
 Roller : d = delrin / a = steel / bn = ball bearing + nylon ring
 Rollen : d = Delrin / a = Stahl / bn = Kugellager mit Nylonauffläche
 Paliers : bz = bronze / l = lisse / b = billes / bp = billes de précision
 Axle : bz = bronze / l = smooth axle / b = ball bearing / bp = precision ball
 Lager : bz = Bronze / l = Flachachse / b = Kugellager / bp = Präzisionskugellager



 Désignation		ref				Ø	H	L
 Description								
 Beschreibung								

CHARIOTS GL ARMATURE ACIER



 GL Trolleys Steel body	9040	9842GL	150	a	bp	14.5	42	90
 Transporthänger GL Stahl mit seitlicher Führung	9050	9852GL	250	a	bp	16.5	55	107
	9060	9862GL	500	a	bp	20.5	62	130

CHARIOTS GL HAUTE TEMPÉRATURE

MAX 250°



 High temperature GL Trolleys	9040	9842GLHT	150	a	b	14.5	42	90
 Transporthänger GL für Hochtemperaturen mit seitlicher Führung	9050	9852GLHT	250	a	b	16.5	55	107
	9060	9862GLHT	500	a	b	20.5	62	130

CHARIOTS GLR



 GLR Trolleys	9040	9842GLR	70	a	bp	M16	92	90
 Transporthänger GL mit seitlicher Führung und Kugelgelenk	9050	9852GLR	200	a	bp	M20	115	107
	9060	9862GLR	400	a	bp	M24	126	130

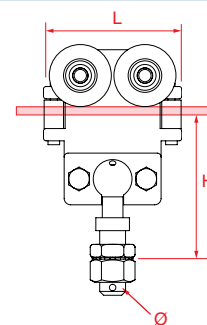
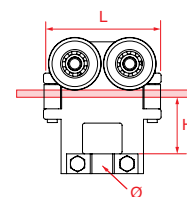

CHARIOTS GLR HAUTE TEMPÉRATURE

MAX 250°

 High temperature GLR trolleys	9040	9842GLRHT	70	a	b	M16	92	90
 Transporthänger GL für Hochtemperaturen	9050	9852GLRHT	200	a	b	M20	115	107
	9060	9862GLRHT	400	a	b	M24	126	130



 **Galets** : d = delrin / a = acier / bn = billes + bandage nylon
 **Roller** : d = delrin / a = steel / bn = ball bearing + nylon ring
 **Rollen** : d = Delrin / a = Stahl / bn = Kugellager mit Nylonauflache

 **Paliers** : bz = bronze / l = lisse / b = billes / bp = billes de précision
 **Axle** : bz = bronze / l = smooth axle / b = ball bearing / bp = precision ball
 **Lager** : bz = Bronze / l = Flachachse / b = Kugellager / bp = Präzisionskugellager





ANNEAUX

🇬🇧 Rings / 🇩🇪 Ring

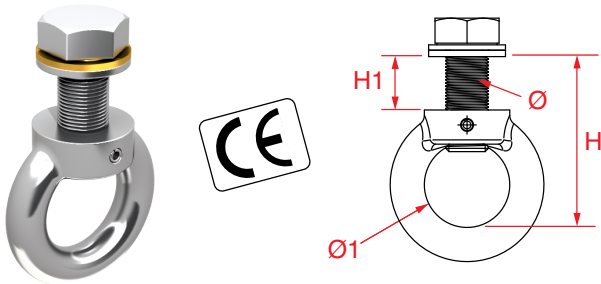

☐	ref	Ø1	Ø	H	H1	kg
9010	8331	25	10	48	13	25
9030	8531	29	12	57	16	60
9040	8631	30	14	60	19	150
9050/9060	8731	35	16	73	25	250
9050	8831	35	16	67	19	250
9060	8831S	40	20	80	25	500
9070	8931	60	30	115	31	1000

CROCHETS

🇬🇧 Hooks / 🇩🇪 Haken

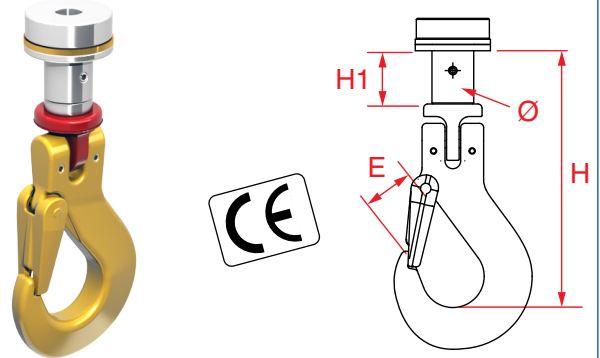

☐	ref	Ø	E	H	H1	kg
9040	8632	14	20	116	19	150
9050/9060	8732	16	20	122	25	250
9050	8832	16	20	116	19	250
9060	8832S	20	20	123	25	500
9070	8932	30	20	128	31	1000

BUTÉE EN LIGNE MANUELLE

🇬🇧 Manual online stopper
🇩🇪 Manuelle online Stopper

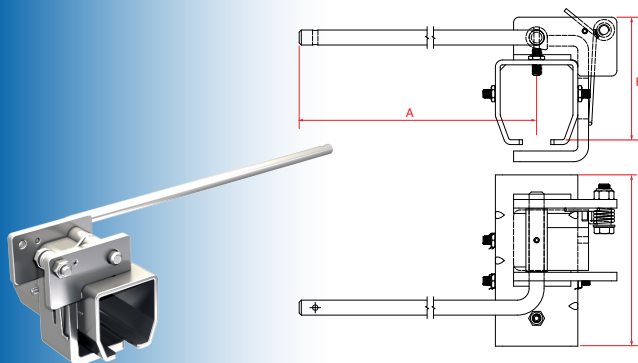

☐	ref	A	B	H
9030	9139BT	268	115	67
9040	9149BT	268	135	76
9050	9159BT	420	160	115
9060	9169BT	420	205	129

BUTÉE EN LIGNE PNEUMATIQUE

🇬🇧 Pneumatic online stopper
🇩🇪 Pneumatische online Stopper

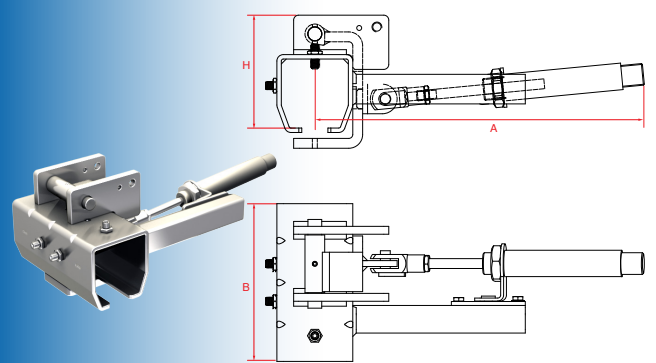

☐	ref	A	B	H
9030	9139BTP	271	115	67
9040	9149BTP	273	135	76
9050	9159BTP	332	160	115
9060	9169BTP	342	205	129

BUTÉE

🇬🇧 Stoppers / 🇩🇪 Stopper

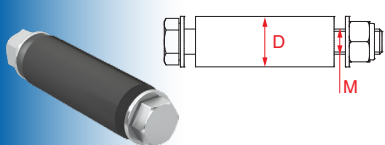

☐	ref	M	D
9040	9147	M10	20
9050	9157	M10	20
9060	9167	M12	25

BUTÉE COURTE

🇬🇧 Short stoppers / 🇩🇪 Stopper kurz

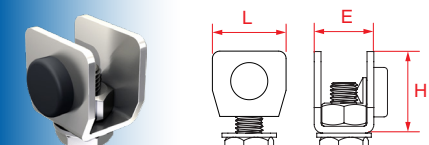

☐	ref	E	H	L
9010	9118	17.5	24	25
9030	9138	24	28	33
9040	9148	28	35	39.5
9050	9158	35	50	55

BUTÉE LONGUE

🇬🇧 Long stoppers / 🇩🇪 Stopper lang

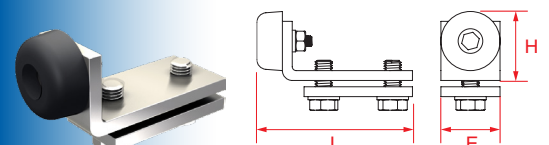

☐	ref	E	H	L
9030	9139	20	23	72
9040	9149	30	30	78
9050	9159	40	48	113
9060 / 9070	9169	50	60	104



Désignation Description Beschreibung		ref	kg			MAX	H	L
--	--	-----	----	--	--	-----	---	---

■ ■ PORTE CÂBLE PLAT NYLON

Nylon flat cable carriers Flachkabelträger Nylon								
	9010	99412P	6	d	b	45x20	24.5	70
	9030	99432P	6	d	b	45x20	44	133
		99432PS	6	d	b	70x20	44	133
	9040	99442P	6	d	b	45x20	40.5	133
	10400	99442PS	6	d	b	70x20	40.5	133
	9050	99452P	10	d	b	45x20	33	133
	10500	99452PS	10	d	b	70x20	33	133
	9060	99462P	10	d	b	45x20	26	133
10600	99462PS	10	d	b	70x20	26	133	

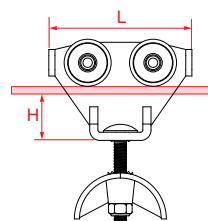

■ ■ PORTE CÂBLE PLAT ACIER

Steel flat cable carriers Flachkabelträger Stahl								
	9010	9412P	10	a	b	45x20	37	90
		9412PS	10	a	b	70x20	36	90
		9412PSF*	10	a	b	70x20	19	78
	9030	9432P	15	a	b	45x20	61	89
	9040	9442P	15	a	b	45x20	56	118
	9050	9452P	20	a	b	45x20	52	156
	9060	9462P	20	a	b	45x20	45	156
	9070	2482P	20	n	b	70x20	37.5	156

* armature non articulée unarticulated body

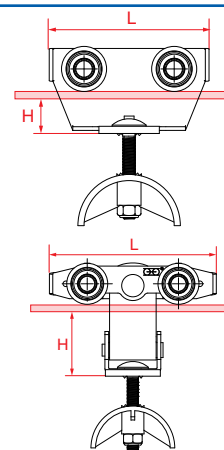

■ ■ PORTE CÂBLE PLAT ENTRAÎNEUR

Lead trolleys Mitnehmerwagen								
	9010	9413P	10	a	b	45x20	46	197
		9413PS	10	a	b	70x20	46	197
	9030	9433P	15	a	b	45x20	43	197
		9433PS	15	a	b	70x20	43	197
	9040	9443P	15	a	b	45x20	75	200
		9443PS	15	a	b	70x20	75	200
	9050	9453P	20	a	b	45x20	67	200
		9453PS	20	a	b	70x20	67	200
	9060	9463P	20	a	b	45x20	60	200
		9463PS	20	a	b	70x20	60	200

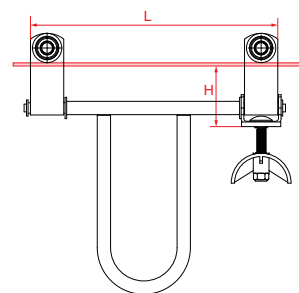

■ ■ PORTE CÂBLE PLAT FIXE

End flat cable carriers Endklemme							
	9010	9414P	6			45x20	68
		9414PS	6			70x20	68
	9030	9434PS	6			70x20	68
	9040						
	10400						
	9050	9454PS	10			70x20	68
10500							
9060							
10600							
9070							

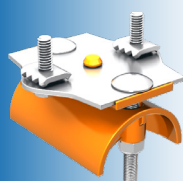
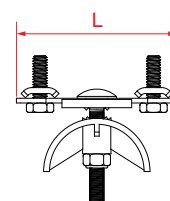

Galets : d = delrin / a = acier / bn = billes + bandage nylon
Roller : d = delrin / a = steel / bn = ball bearing + nylon ring
Rollen : d = Delrin / a = Stahl / bn = Kugellager mit Nylonauffläche
Paliers : bz = bronze / l = lisse / b = billes / bp = billes de précision
Axle : bz = bronze / l = smooth axle / b = ball bearing / bp = precision ball
Lager : bz = Bronze / l = Flachachse / b = Kugellager / bp = Präzisionskugellager



Désignation Description Beschreibung		ref	kg				MAX	H	L
--	--	-----	----	--	--	--	-----	---	---

■ ■ PORTE CÂBLE ROND NYLON

Nylon round cable carriers Rundkabelträger Nylon									
	9010	99412R	6	d	b	$10 \geq \emptyset \geq 20$	61	70	
	9030	99432R	6	d	b	$10 \geq \emptyset \geq 25$	80	133	
	9040 10400	99442R	6	d	b	$10 \geq \emptyset \geq 25$	77	133	
	9050 10500	99452R	10	d	b	$10 \geq \emptyset \geq 25$	69.5	133	
	9060 10600	99462R	10	d	b	$10 \geq \emptyset \geq 25$	62.5	133	

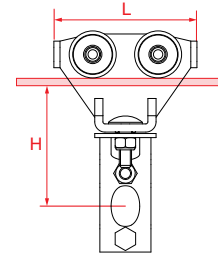

■ ■ PORTE CÂBLE ROND ACIER ARTICULÉ

Steel round cable carriers Rundkabelträger Stahl									
	9010	9412R	10	a	b	$10 \geq \emptyset \geq 25$	68	90	
	9030	9432R	10	a	b	$10 \geq \emptyset \geq 25$	93	89	
	9040	9442R	15	a	b	$10 \geq \emptyset \geq 25$	88	118	
	9050	9452R	15	a	b	$10 \geq \emptyset \geq 25$	83	156	
	9060	9462R	15	a	b	$10 \geq \emptyset \geq 25$	76	156	
	9070	2482R	20	n	b	$10 \geq \emptyset \geq 25$	64	153	

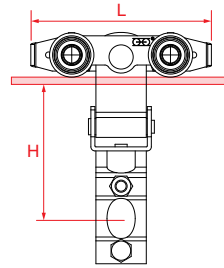
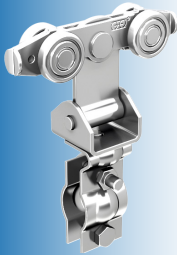

■ ■ PORTE CÂBLE ROND ENTRAÎNEUR

Lead trolleys Mitnehmerwagen									
	9010	9413R	10	a	b	$10 \geq \emptyset \geq 25$	78	197	
	9030	9433R	10	a	b	$10 \geq \emptyset \geq 25$	74	197	
	9040	9443R	15	a	b	$10 \geq \emptyset \geq 25$	106	200	
	9050	9453R	15	a	b	$10 \geq \emptyset \geq 25$	98	200	
	9060 9070	9463R	15	a	b	$10 \geq \emptyset \geq 25$	92	200	

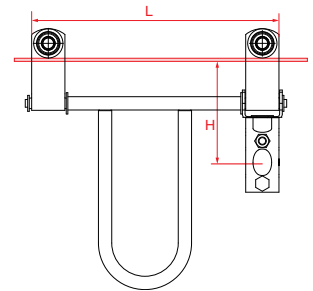

■ ■ PORTE CÂBLE ROND FIXE

End round cable carriers Endklemme									
	9010	9414R	10			$10 \geq \emptyset \geq 25$	35.5	68	
	9030	9434R	10			$10 \geq \emptyset \geq 20$	35.5	68	
	9040 10400	9434R	10			$10 \geq \emptyset \geq 20$	35.5	68	
	9050 10500 9060 10600 9070	9454R	15			$10 \geq \emptyset \geq 20$	35.5	68	

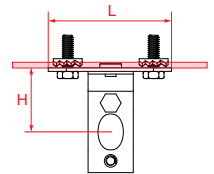

Galets : d = delrin / a = acier / bn = billes + bandage nylon
 Roller : d = delrin / a = steel / bn = ball bearing + nylon ring
 Rollen : d = Delrin / a = Stahl / bn = Kugellager mit Nylonauffläche

Paliers : bz = bronze / l = lisse / b = billes / bp = billes de précision
 Axle : bz = bronze / l = smooth axle / b = ball bearing / bp = precision ball
 Lager : bz = Bronze / l = Flachachse / b = Kugellager / bp = Präzisionskugellager

L'utilisation des produits mantion nécessite la connaissance préalable obligatoire de nos notices techniques, disponibles sur demande.
 The use of MANTION products requires the obligatory preliminary knowledge of our technical notes. Available upon request.
 Die Verwendung der MANTION-Produkte setzt die Kenntnis unserer Technischen Informationen und Anleitungen zwingend voraus.

> Porte tube

Vaccum hose / Schlauchwagen



Désignation Description Beschreibung		ref					H	L
--	--	-----	--	--	--	--	---	---

■ ■ CHARIOTS PORTE TUBE ACIER								
Steel vaccum hose trolley Schlauchwagen Stahl	9040 10400	9442NT	5	bn	b	80	225	65
	9050 10500	9452NT	5	bn	b	80	225	65
	9060 10600	9462NT	5	bn	b	80	225	65

■ ■ CHARIOTS PORTE TUBE EN INOX								
Stainless steel vaccum hose trolley Schlauchwagen Edelstahl	9040XA2	9442TXA2	5		bp	80	225	65
	9050XA2	9452TXA2	5		bp	80	225	65

■ ■ CHARIOTS PORTE TUBE NYLON								
Nylon vaccum hose trolley Schlauchwagen Nylon	9010	99412T	5	a	b	80	270	70
	9030	99432T	5	a	b	80	290	133
	9040 10400	99442T	5	a	b	80	285	133
	9050 10500	99452T	5	a	b	80	280	133
	9060 10600	99462T	5	a	b	80	270	133

■ ■ POINT FIXE								
Vaccum hose fixed point Fix Punkt Nylon	9030 9040 10400	9434T	5			80	275	
	9050 10500 9060 10600	9454T	5			80	270	

■ ■ POINT FIXE INOX								
Stainless steel vaccum hose fixed point Fix Punkt Edelstahl	9030XA2 9040XA2	9434TXA2	5			80	275	
	9050XA2	9454TXA2	5			80	270	

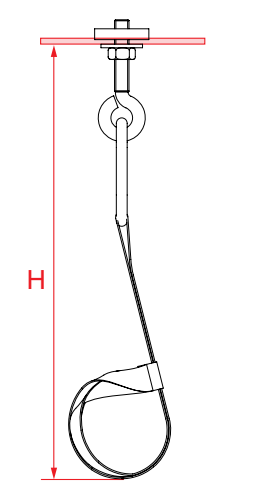
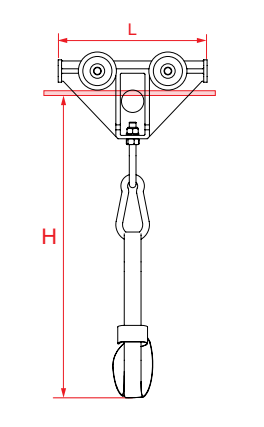
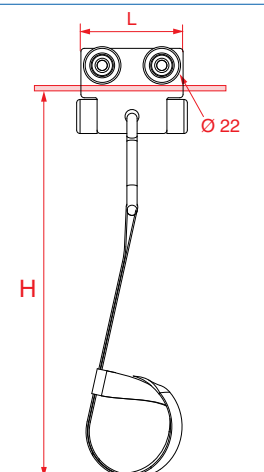

Galets : a = acier - Paliers : b = billes

Roller : a = steel - Axle : b = ball bearing

Rollen : a = Stahl - Lager : b = Kugellager

PLAQUETTE PORTE CÂBLE ROND

Extension for round cable carriers
Verlängerung für Rundkabel

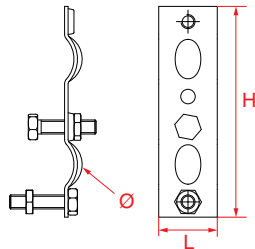

□	ref	Ø	H	L
9010 → 9070 10400 → 10600	410	10 ≥ Ø ≥ 25	90	25

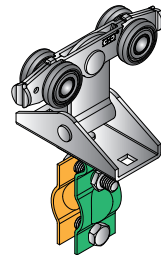

9412R



410

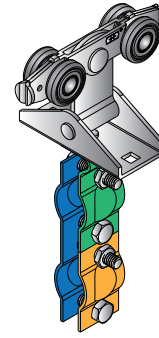

9412R + 410

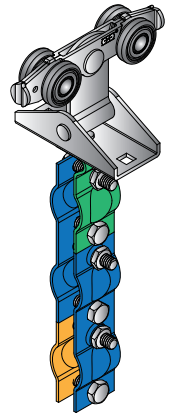

9412R + 410 + 410

PORTE CÂBLE NYLON NU

Nylon cable carriers
Endverteilerwagen Nylon

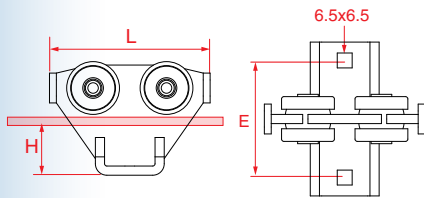

□	ref	H	L	E
9010	99416	25	70	51
9030	99436	44	133	51
9040 10400	99446	40.5	133	51
9050 10500	99456	33	133	51
9060 10600	99466	26	133	51

PORTE CÂBLE ACIER NU

Steel cable carriers
Endverteilerwagen Stahl

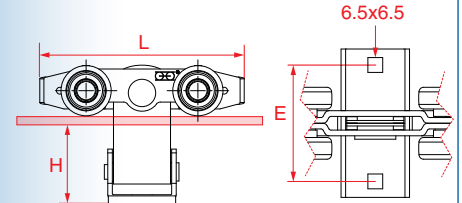

□	ref	H	L	E
9010	9416	35	90	51
9030	9436	59	89	51
9040	9446	54	118	51
9050	9456	49.5	156	51
9060 9070	9466	42.5	156	51

BRIDES

Clamps
Klemme

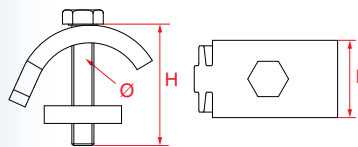

□	ref	Ø	H	L
9010 9030	16464BRID	M8	50	30
9040	16465BRID	M10	55	35

BOULONS

Bolts
Klemm-Mutter

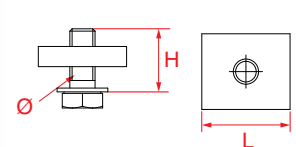

□	ref	Ø	H	L
9010 9030	16735BOUL	M8	25	30
9040	16736BOUL	M10	25	35

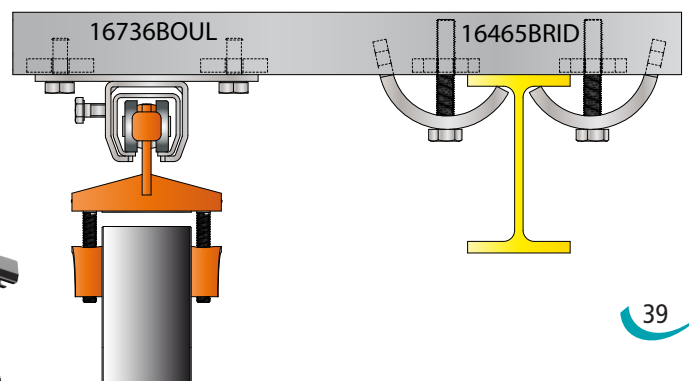

RAILS

Tracks / Schienen

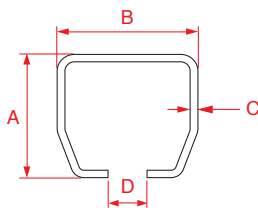
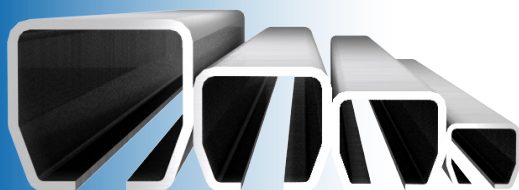

□	304L	316L	A	B	C	D
9010	9010XA2/6	9010XA4/6	28	30	1.5	10
9030	9030XA2/6	9030XA4/6	35	40	2.5	12
9040	9040XA2/6	9040XA4/6	43.5	48.5	3	15
9050	9050XA2/6	-	60	65	3.5	18

SOMMIERS RIGIDES

Rigid end crane trolleys / Starre Schiebebühnen-Fahrwerke

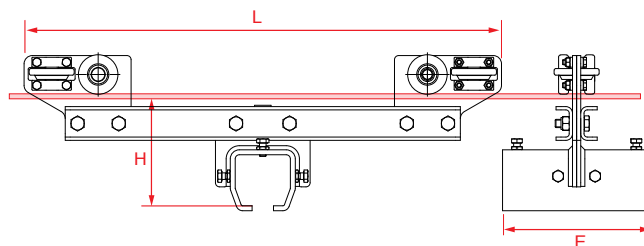

□	ref - 304L	kg			L	H	E
9040	9748SR40XA2	100	a	bp	530	107	145
9050	9758SR50XA2	200	a	bp	580	132	180

SOMMIERS ARTICULÉS

Articulated end crane trolleys / Schwenkbare Laufwerke

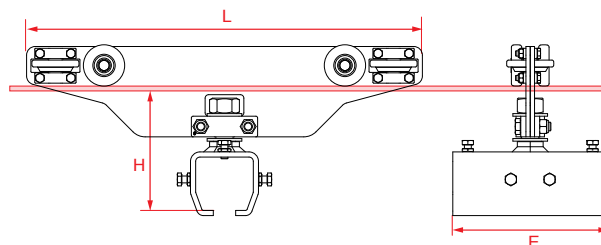
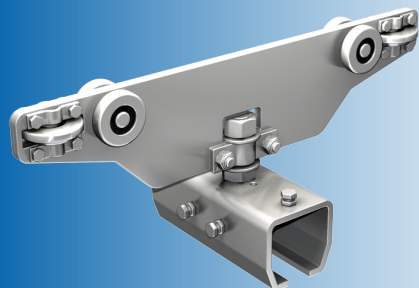

□	ref - 304L	kg			L	H	E
9040	9848SA40XA2	100	a	bp	390	121	145
9050	9858SA50XA2	200	a	bp	460	147	180

Galets : d = delrin / a = acier / bn = billes + bandage nylon
Paliers : bz = bronze / l = lisse / b = billes / bp = billes de précision
Roller : d = delrin / a = steel / bn = ball bearing + nylon ring
Axle : bz = bronze / l = smooth axle / b = ball bearing / bp = precision ball
Rollen : d = Delrin / a = Stahl / bn = Kugellager mit Nylonauffläche
Lager : bz = Bronze / l = Flachachse / b = Kugellager / bp = Präzisionskugellager

SUPPORT À SOUDER

Weld on brackets
Anschweissmuffe

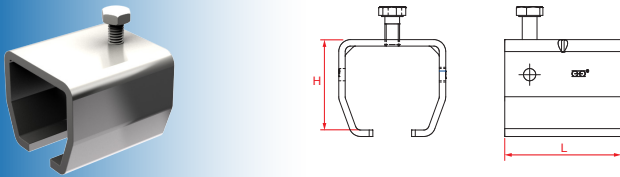

□	304L	316L	H	L
9010	9018XA2	9018XA4	32	40
9030	9038XA2	9038XA4	39.5	54
9040	9048XA2	9048XA4	49	65
9050	9058XA2	-	68	90

SUPPORT À TIGE FILETÉE

Adjustable brackets
Höhenverstellbare Muffe

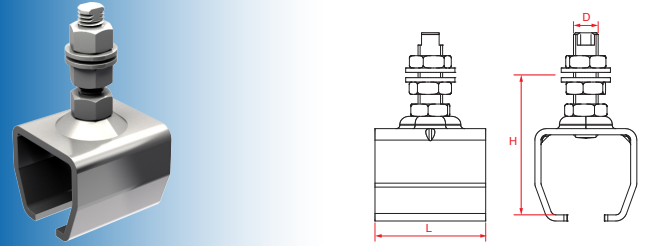

□	304L	316L	D	L	H
9010	9011XA2	9011XA4	M10	40	58 ±5
9030	9031XA2	9031XA4	M14	54	72 ±5
9040	9041XA2	9041XA4	M14	65	81 ±5
9050	9051LXA2	-	M20	80	139 ±30

SUPPORT À FIXATION MURALE

Wall fixing brackets
Wandmuffe

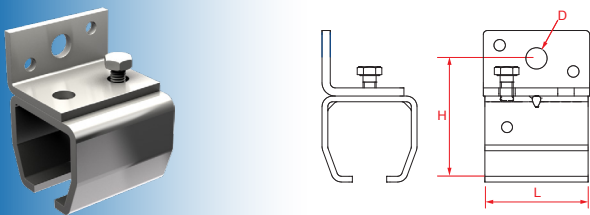

□	304L	316L	D	L	H
9010	9018VXA2	9018VXA4	9	40	46
9030	9038VXA2	9038VXA4	11	54	56
9040	9048VXA2	9048VXA4	13	65	72
9050	9058VXA2	-	14	90	96

SUPPORT À SERRAGE NU

Clamping brackets
Klemm-Muffe

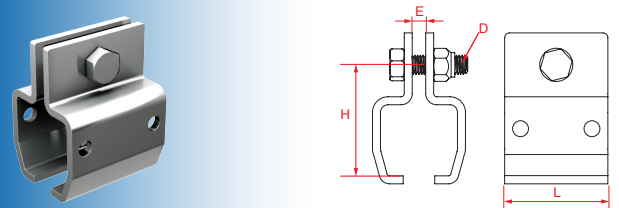

□	ref	D	E	L	H
9030	9032NXA2	M12	8	54	59
9040	9042NXA2	M12	8	65	70
9050	9052NXA2	M16	10	90	89

SUPPORT PLAFOND

Roof fixing brackets
Deckenmuffe

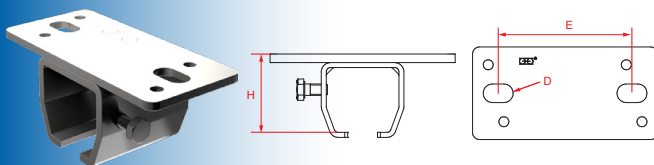

□	304L	316L	D	E	H
9010	9018HXA2	9018HXA4	9	70	35
9030	9038HXA2	9038HXA4	11	81	43.5
9040	9048HXA2	9048HXA4	13	94	54
9050	9058HXA2	-	17	125	74

MANCHON DE RACCORDEMENT

Joining brackets
Verbindungsmuffe

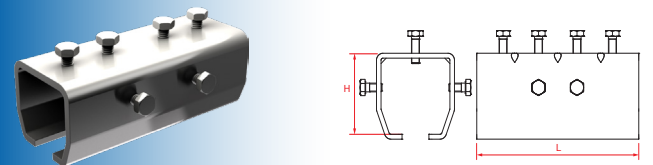

□	304L	316L	H	L
9010	9011MXA2	9011MXA4	32	80
9030	9031MXA2	9031MXA4	39.5	115
9040	9041MXA2	9041MXA4	49	145
9050	9051MXA2	-	68	180



Galets : d = delrin / a = acier

Roller : d = delrin / a = steel

Rollen : d = Delrin / a = Stahl

Paliers : bz = bronze / l = lisse / bp = billes de précision

Axle : bz = bronze / l = smooth axle / bp = precision ball

Lager : bz = Bronze / l = Flachachse / bp = Präzisionskugellager

Désignation Description Beschreibung		ref 304L	ref 316L	kg			Ø	H	L	
	9030	99731XA2	99731XA4	10	d	l	10	33.5	49	
	9010	99712XA2	-	10	d	bz	8.2	38	87	
	9030	99732XA2	99732XA4	20	d	bz	8.2	33.5	89	
	9030	9732XSA2	9732XSA4	50	a	bp	8.2	33.5	89	
	9040	9742XSA2	9742XSA4	100	a	bp	14	43	118	
	9030	99832XA2	99832XA4	20	d	bz	12.5	22	89	
	9030	9832XSA2	9832XSA4	50	a	bp	12.5	22	89	
	9040	9842XSA2	9842XSA4	100	a	bp	15	23	118	
	9040	9742WRXSA2	9742WRXSA4	100	a	bp	14	40	100	
	9050	9752WRXSA2	-	200	a	bp	18	43	128	
	9040	9842XSPA2	9842XSPA4	100	a	bp	14.5	32	98	
	9050	9852XSPA2	-	200	a	bp	16.5	42	128	

BUTÉE

Stoppers / Stopper

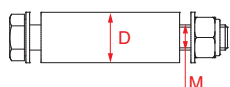

	ref	M	D	
	9040	9147XA2	M10	20
	9050	9157XA2	M12	25

BUTÉE COURTE

Short stoppers Stopper kurz

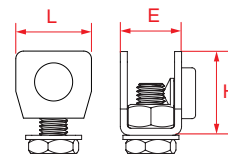

	304L	316L	C	H	L	
	9010	9118XA2	9118XA4	17.5	24	25

BUTÉE LONGUE

Long stoppers / Stopper lang

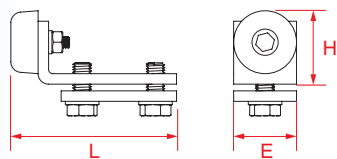
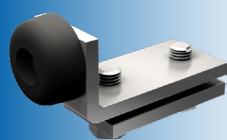

	304L	316L	E	H	L	
	9030	9139XA2	9139XA4	20	23	72
	9040	9149XA2	9149XA4	30	30	78
	9050	9159XA2	-	40	48	115

ANNEAUX

Rings / Ring

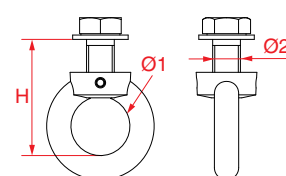

	304L	Ø1	Ø2	H	kg	
	9030	8521XA2	29	12	57	50
	9040	8621XA2	30	14	60	100
	9050	8821XA2	34	16	67	200

■ ■ PURTEC by MANTION propose une large gamme de potences aluminium triangulées : en fixation murale ou sur fût.

DEMANDEZ NOTRE CATALOGUE 832J

■ PURTEC by MANTION offers also a large range of aluminium jib cranes: column slewing jib crane and wall slewing jib crane.

ASK OUR CATALOGUE 832J

■ PURTEC von MANTION bietet auch eine große Auswahl an Aluminium-Auslegerkränen an: Säulenschwenkkräne und Wandschwenkkräne.

FORDERN SIE UNSEREN KATALOG 832J AN



■ ■ Catalogue 832J
■ Catalogue 832J



■ Katalog 832J

■ ■ PURTEC by MANTION propose une large gamme de poutres roulantes aluminium.

DEMANDEZ NOTRE CATALOGUE 832C

■ PURTEC by MANTION offers also a large range of aluminium cranes.

ASK OUR CATALOGUE 832J

■ PURTEC von MANTION bietet auch eine große Auswahl an Aluminium-Auslegerkränen an: Säulenschwenkkräne und Wandschwenkkräne.

FORDERN SIE UNSEREN KATALOG 832J AN



■ ■ Catalogue 832C
■ Catalogue 832C



■ Katalog 832C

■ ■ Grâce à son profil HERCULE, Manton propose aussi une large gamme de matériel de monorail:

- convoyeur motorisé, stations élévatrices...
- aiguillages, plaques tournantes, distributeurs indexés...

DEMANDEZ NOTRE CATALOGUE 821

■ Thanks the HERCULE track, Manton propose also a large range of material for monorail:

- motorised conveyors, drop sections...
- switches, turn-tables...

ASK OUR CATALOGUE 821

■ Dank des HERCULE Profils bietet auch Manton eine breite Palette von Handhängebahn :

- Drehweichen, Zungenweichen...
- Schleppförderer, Drehschiebweichen, Hebestationen...

FRAGEN SIE NACH UNSERE KATALOG 821 HANDHÄNGEBAHN



■ ■ Catalogue 832C
■ Catalogue 832C



■ Katalog 832C

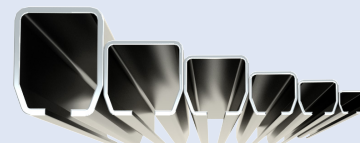



MANTION® SAS

7 rue Gay Lussac | FRANCE - 25000 Besançon
Tél. + 33 3 81 50 56 77 | Fax. + 33 3 81 53 29 76
E-mail : mantion@mantion.com

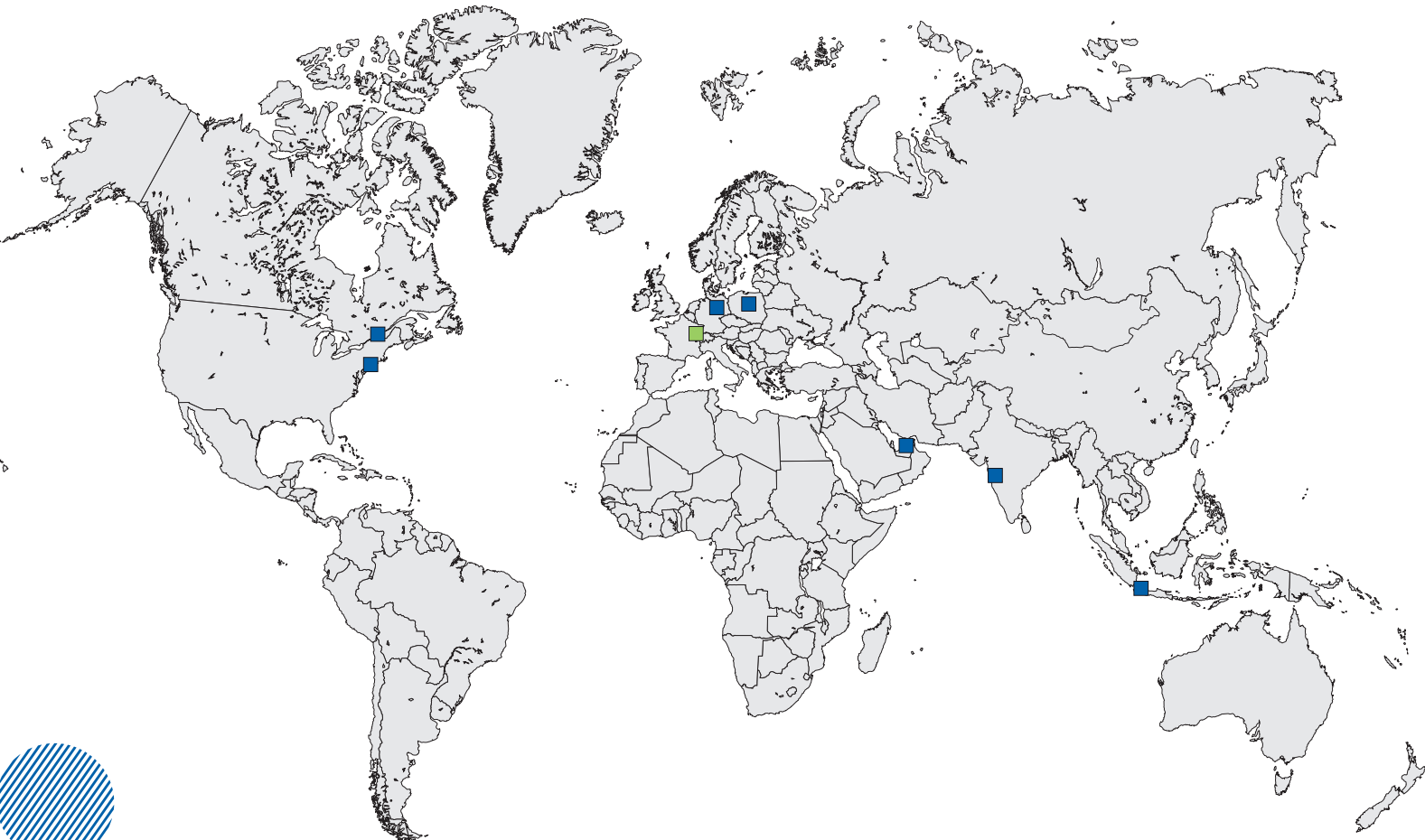

Allemagne / Autriche

Germany / Austria

Mantion Baubeschläge GMBH

Dieselstraße 18
D-42579 HEILIGENHAUS
Tél. + 49 2056 58 26 90
Fax. + 49 2056 58 26 99
Email : info@mantion.de
www.mantion.de

Moyen Orient

Middle East

Dubaï Branch Office

Jafza South, unit no. S101 23 O 032,
Jebel Ali Free Zone, Dubai, UAE
Dubai & Bahrain : Tél. +971 56 174 58 44
Reste du Moyen Orient : +971 56 739 66 11
Email : export@mantion.com
www.mantion.com

Asie du Sud-Est

South-East Asia

Mantion South-East Asia

Sovereign Plaza Lantai 8 Unit D E
Jl. TB Simatupang No.Kav. 36, Kec. Cilandak,
Jakarta Selatan, 12430
INDONESIA
Email : export@mantion.com
www.mantion.com

Europe de l'Est

East Europe

Mantion Polska

ul Boruty 2a
PL-03 769 WARSZAWA
Tél. + 48 22 818 77 22
Fax. + 48 22 818 99 78
Email : biuro@valcomp.com.pl
www.valcomp.com.pl

Inde

India

Mantion India Private Ltd

G-19, T.V. Estate, 248/A, S.K. Ahire Marg, Worli
Mumbai - 400030. INDIA
Mobile. +91 (0) 9819 30 38 78
Email : support.india@mantion.com
www.mantion.com

Amérique du Nord

North America

Mantion Canada

12-360 boul. Séminaire N
Saint-Jean-sur-Richelieu
Québec J3B 5L1
Tél. + 1 (450) 529 1315
E-mail : contact@mantion-na.com
www.mantion.ca

Mantion USA

450 7th avenue, suite 1501
New York NY 10123
Tél. + 1 (475) 289-0254
E-mail : contact@mantion-us.com
www.mantion.us

UN NOUVEAU REGARD SUR LA MANUTENTION AÉRIENNE

A NEW GLANCE AT THE MANUEL OPERATED HANDLING SYSTEM

EIN NEUER BLICK AUF DIE HÄNGEFÖRDERTECHNIK