



MANTION

WWW.MANTION-MANUTENTION.COM

Chandelles d'accrochage sur charpente

Hangers for steel buildings

Zuganker für Stahlbau



822/2





Chandelle inclinable dans le sens de la charpente
Inclined hangers / Zugankern

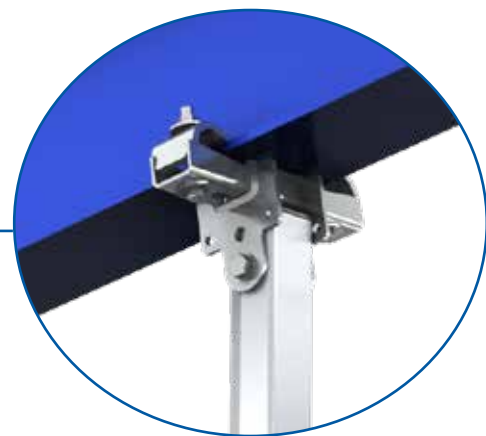

Chandelle courte

Short hanger / Kurze Aufhängungen

from IPE 180 - 360 to HEA 100 - 160

	ref	H (mm)	M
	9040 9047CC	155	M14
	9050 9057CC	160	M20
	9060 9067CC	165	M20

	ref	H (mm)	M
	10400 10567CC	158	M12
	10500 10567CC	158	M12
	10600 10667CC	170	M16

from IPE 300 - 600 to HEA 160 - 300

	ref	H (mm)	M
	9140 9147CC	160	M14
	9150 9157CC	165	M20
	9160 9167CC	170	M20

	ref	H (mm)	M
	11400 11567CC	163	M12
	11500 11567CC	163	M12
	11600 11667CC	175	M16

Chandelle longueur spéciale

Special length hanger / Lange Aufhängungen

from IPE 180 - 360 to HEA 100 - 160

	ref	H*	M
	9040 9047CLSP	xx	M14
	9050 9057CLSP	xx	M20
	9060 9067CLSP	xx	M20

	ref	H*	M
	10400 10567CLSP	xx	M12
	10500 10567CLSP	xx	M12
	10600 10667CLSP	xx	M16

from IPE 300 - 600 to HEA 160 - 300

	ref	H*	M
	9140 9147CLSP	xx	M14
	9150 9157CLSP	xx	M20
	9160 9167CLSP	xx	M20

	ref	H*	M
	11400 11567CLSP	xx	M12
	11500 11567CLSP	xx	M12
	11600 11667CLSP	xx	M16

Chandelle à composer

To be composed hanger / Kombinationsmöglichkeiten eines Zugankers

from IPE 180 - 360 to HEA 100 - 160

	ref	H (mm)	M
9040	10507CH	105	M14
9050	10607CH	110	M14
	ref	H (mm)	M
10400	10507CH	105	M14
10500	10607CH	110	M14
10600	10607CH	110	M14

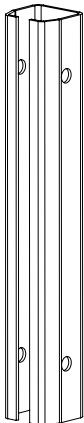
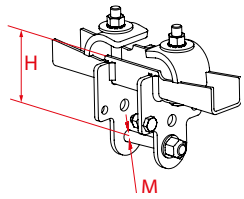

Profil 9050
9050 profil
9050 Schienenprofil

from IPE 300 - 600 to HEA 160 - 300

	ref	H (mm)	M
9040	11507CH	110	M14
9050	11607CH	115	M14
9060	11607CH	115	M14
	ref	H (mm)	M
10400	11507CH	110	M14
10500	11607CH	115	M14
10600	11607CH	115	M14

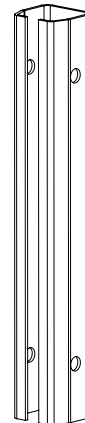
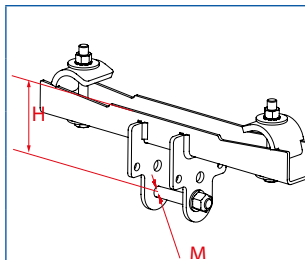

Profil 9050
9050 profil
9050 Schienenprofil

	ref	H (mm)	M
9040	9047CB	85	M14
9050	9057CB	90	M20
9060	9067CB	90	M20
	ref	H (mm)	M
10400	10507CB	88	M12
10500	10507CB	88	M12
10600	10607CB	95	M16

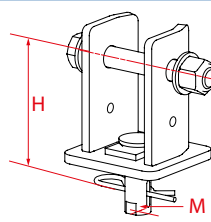
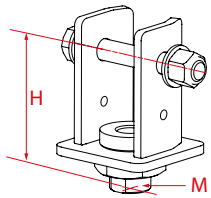

	ref	H (mm)	M
9040	9047CB	85	M14
9050	9057CB	90	M20
9060	9067CB	90	M20
	ref	H (mm)	M
10400	10507CB	88	M12
10500	10507CB	88	M12
10600	10607CB	95	M16

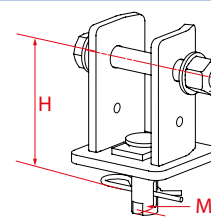
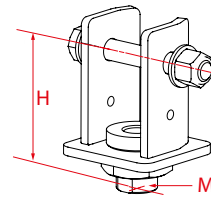

Anti rotation + Triangulation + Gabarit de perçage

Anti rotating + stabilisation + Drilling template / Stabilisierung + Dreiecksaufnahme + Bohrschablone

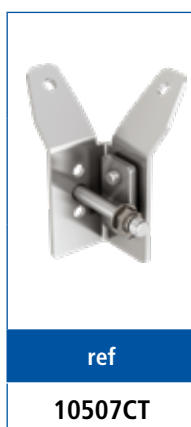



Chandelle inclinable perpendiculaire à la charpente
Perpendicular inclined hangers / Quer Zuganker

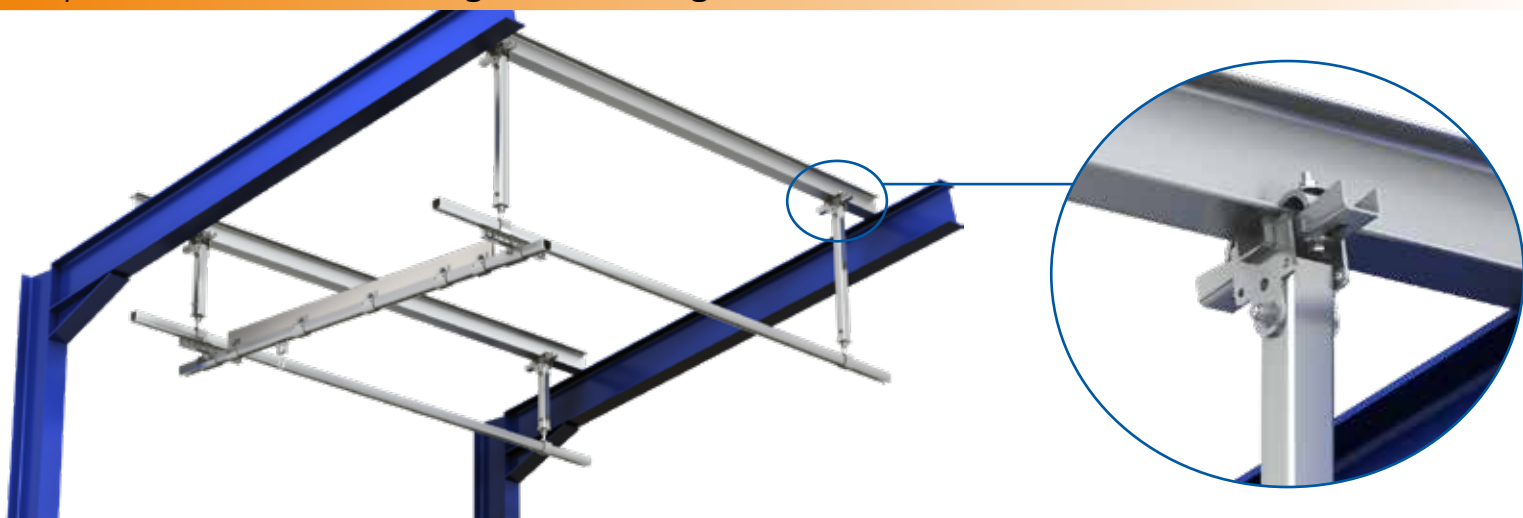

Chandelle courte

Short hanger / Kurze Aufhängungen

from IPE 100 - 360 to HEA 100 - 160

	ref	H (mm)	M	
	9040	9045CC	155	M14
	9050	9055CC	160	M20
	9060	9065CC	165	M20

	ref	H (mm)	M	
	10400	10565CC	158	M12
	10500	10565CC	158	M12
	10600	10665CC	170	M16

from IPE 300 - 600 to HEA 160 - 300

	ref	H (mm)	M	
	9040	9145CC	160	M14
	9050	9155CC	165	M20
	9060	9165CC	170	M20

	ref	H (mm)	M	
	10400	11565CC	163	M12
	10500	11565CC	163	M12
	10600	11665CC	175	M16

Chandelle longueur spéciale

Special length hanger / Lange Aufhängungen

from IPE 100 - 360 to HEA 100 - 160

	ref	H*	M	
	9040	9045CLSP	xx	M14
	9050	9055CLSP	xx	M20
	9060	9065CLSP	xx	M20

	ref	H*	M	
	10400	10565CLSP	xx	M12
	10500	10565CLSP	xx	M12
	10600	10665CLSP	xx	M16

from IPE 300 - 600 to HEA 160 - 300

	ref	H*	M	
	9040	9145CLSP	xx	M14
	9050	9155CLSP	xx	M20
	9060	9165CLSP	xx	M20

	ref	H*	M	
	10400	11565CLSP	xx	M12
	10500	11565CLSP	xx	M12
	10600	11665CLSP	xx	M16

Chandelle à composer

To be composed hanger / Kombinationsmöglichkeiten eines Zugankers

from IPE 100 - 360 to HEA 100 - 160

		ref	H (mm)	M
	9040 9050	10505CH	105	M14
	9060	10605CH	110	M14
		ref	H (mm)	M
	10400 10500	10505CH	105	M14
	10600	10605CH	110	M14

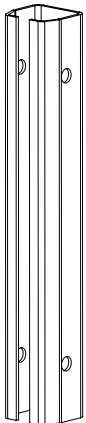

Profil 9050
9050 profil
9050 Schienenprofil

from IPE 300 - 600 to HEA 160 - 300

		ref	H (mm)	M
	9040 9050	11505CH	110	M14
	9060	11605CH	115	M14
		ref	H (mm)	M
	10400 10500	11505CH	110	M14
	10600	11605CH	115	M14

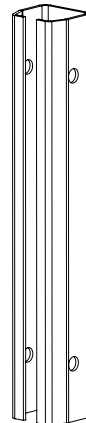

Profil 9050
9050 profil
9050 Schienenprofil

		ref	H (mm)	M
	9040	9047CB	85	M14
	9050	9057CB	90	M20
		ref	H (mm)	M
	10400	10507CB	88	M12
	10500	10507CB	88	M12
10600	10607CB	95	M16	

		ref	H (mm)	M
	9040	9047CB	85	M14
	9050	9057CB	90	M20
		ref	H (mm)	M
	10400	10507CB	88	M12
	10500	10507CB	88	M12
10600	10607CB	95	M16	

Anti rotation + Triangulation + Gabarit de perçage

Anti rotating + stabilisation + Drilling template / Stabilisierung + Dreiecksaufnahme + Bohrschablone

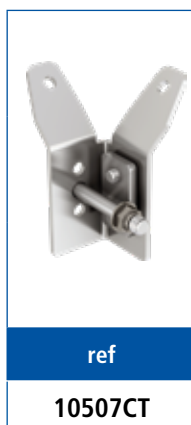



Chandelle plafond béton

Concrete roof hangers / Zuganker für Betondecke



Chandelle longueur spéciale

Special length hanger / Lange Aufhängungen

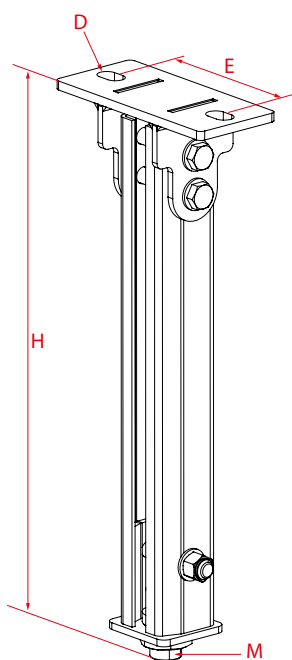

☐	ref	H* (mm)	M	ØD (mm)	E (mm)	
	9040	9046CLSP	xx	M14	17	142
	9050	9056CLSP	xx	M20	17	142
	9060	9066CLSP	xx	M20	21	160

☐	ref	H* (mm)	M	ØD (mm)	E (mm)	
	10400	10566CLSP	xx	M12	17	142
	10500	10566CLSP	xx	M12	17	142
	10600	10666CLSP	xx	M16	21	160

* Cote à préciser à la commande
specify dimension when ordering
genaue Maße bei der Bestellung angeben

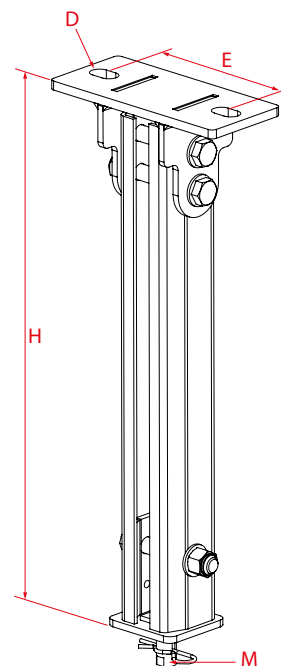

Triangulation + Gabarit de perçage

Stabilisation + Drilling template / Stabilisierung + Bohrschablone

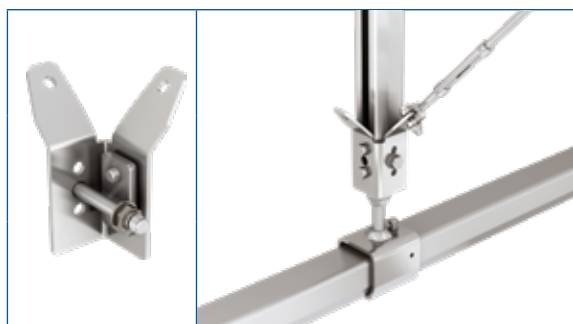

ref

10507CT





ref

10507GAB

Chandelle à composer

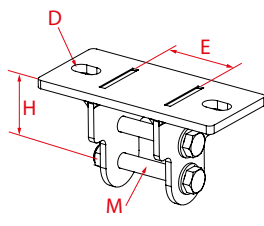
To be composed hanger / Kombinationsmöglichkeiten eines Zugankers

	ref	H (mm)	M (mm)	ØD (mm)	E (mm)	
	9040 9050	10506CH	78	M14	17	142
	9060	10606CH	80	M14	21	160
	ref	H (mm)	M (mm)	ØD (mm)	E (mm)	
	10400 10500	10506CH	78	M14	17	142
	10600	10606CH	80	M14	21	160

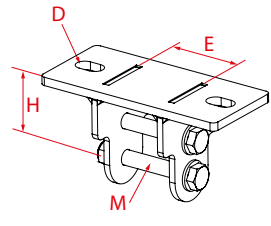
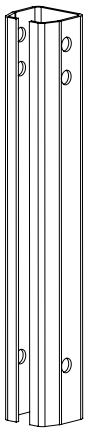

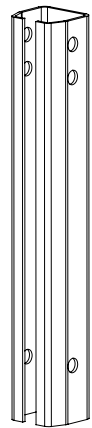

Profil 9050
9050 profil
9050 Schienenprofil

Profil 9050
9050 profil
9050 Schienenprofil

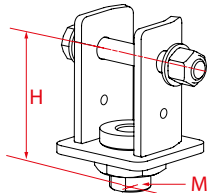

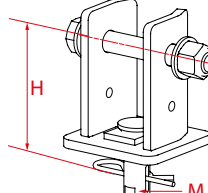
	ref	H (mm)	M	
	9040	9047CB	85	M14
	9050	9057CB	90	M20
	9060	9067CB	90	M20

	ref	H (mm)	M	
	10400	10507CB	88	M12
	10500	10507CB	88	M12
	10600	10607CB	95	M16

Inox

Stainless steel / Edelstahl

Pour une version inox, veuillez nous consulter.

For a stainless steel version, please contact us.

Für eine Ausführung in Edelstahl, kontaktieren Sie uns bitte.





MANTION

MANUTENTION

MANTION S.A.S

7 rue Gay Lussac
F-25000 Besançon
Tel. + 33 3 81 50 56 77
Fax. + 33 3 81 53 29 76
E-mail: mantion@mantion.com
www.mantion.com

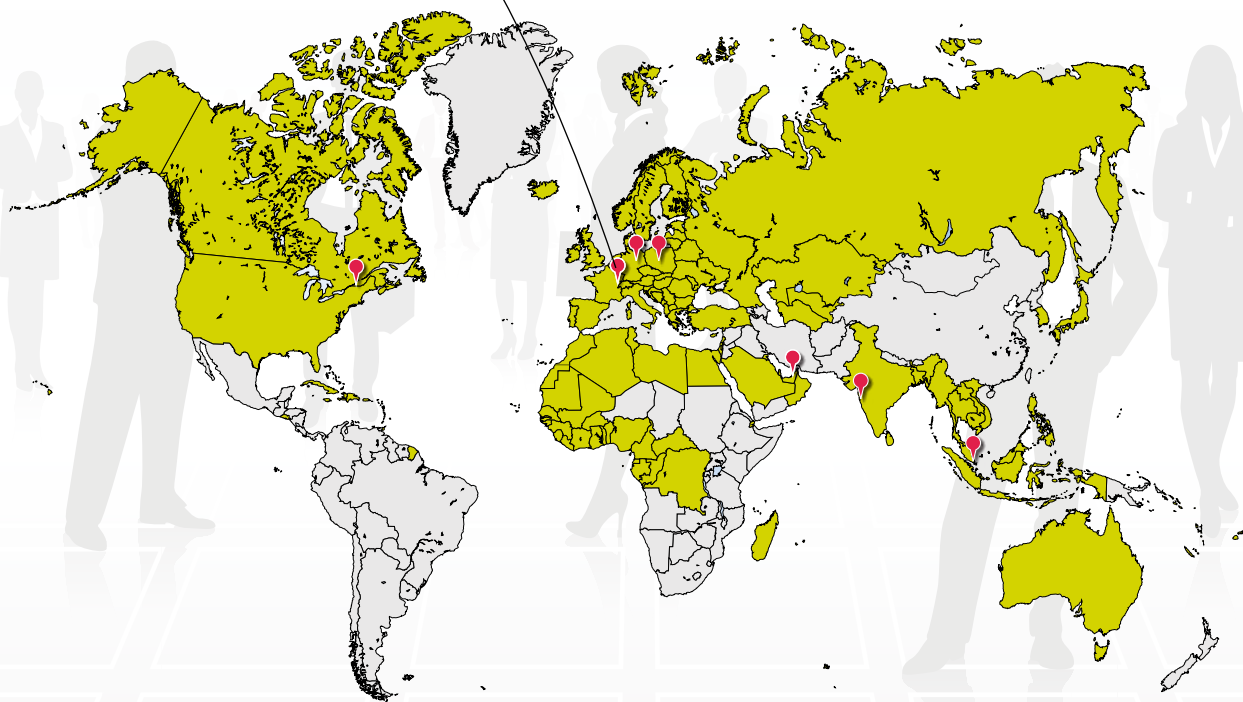

GERMANY / AUSTRIA MANTION BAUBESCHLÄGE GMBH

Dieselstraße 18
D-42579 HEILIGENHAUS
Tel. + 49 2056 58 26 90
Fax. + 49 2056 58 26 99
E-mail: info@mantion.de
www.mantion.de

EAST EUROPE MANTION POLSKA

ul Boruty 2a
PL-03 769 WARSZAWA
Tel. + 48 22 818 77 22
Fax. + 48 22 818 99 78
E-mail: biuro@valcomp.com.pl
www.valcomp.com.pl

MIDDLE EAST DUBAI BRANCH OFFICE

Jafza South, unit no. S101 23 O 032,
Jebel Ali Free Zone, Dubai, UAE
Tel. + 971 56 174 58 44
E-mail: export@mantion.com
www.mantion.com

INDIA MUMBAI BRANCH OFFICE

G-19, Ground floor,
T.V. Estate, 248/A, S.K. Ahire Marg.
Worli, Mumbai. 400030. India.
Mobile. + 91 9819 30 38 78
E-mail: a.gala@mantion.com
www.mantion.com

SOUTH-EAST ASIA MANTION SOUTH EAST ASIA

Pte. Ltd. of 4 Battery Road,
#25-01 Bank of China Building,
Singapore 049908
Mobile. + 65 9147 8440
E-mail: export@mantion.com
www.mantion.com

NORTH AMERICA MANTION NA

6-360 boul. Séminaire N
Saint Jean sur Richelieu
Tel. + 1 (450) 529 1315
E-mail: contact@mantion-na.com
www.mantion.ca